

MINISTRY OF SUPPLY

AERONAUTICAL RESEARCH COUNCIL

CURRENT PAPERS

An Electronic Analyser for Linear Differential Equations

By

J. J. Gait, M.A. and D. W. Allen

Crown Copyright Reserved

LONDON: HIS MAJESTY'S STATIONERY OFFICE
1950

Price 3s 0d. net.



Report No. G.W.1.

December, 1947.

ROYAL AIRCRAFT ESTABLISHMENT

An Electronic Analyser for Linear Differential Equations

by

J.J. Gait, M.A.
and
D.W. AllenSUMMARY

* This report describes preliminary work undertaken to investigate the possibility of constructing an electronic differential analyser. The basic operations required are addition, subtraction, integration and differentiation. Section II describes briefly how these operations may be performed using feedback networks associated with high gain D.C. amplifiers and the Appendices to the report give a more detailed discussion of the accuracy and limitations of these methods. Section III describes the technique of combining a series of such units into a flexible differential analyser and shows, for example, how a linear fifth order differential equation with specified initial conditions would be set up and how appropriate time scales of operation and scale factors would be determined. As an indication of the performance of such an electronic differential analyser the solutions obtained for a fourth order linear differential equation are given in Section IV and compared with the theoretical solutions. An analyser of this type will solve linear differential equations or simultaneous linear differential equations. Its extension to more complex forms of differential equations awaits the development of satisfactory methods of electronic multiplication of two variables.

LIST OF CONTENTS

	<u>Page</u>
I Introduction	3
II The Component Computing Devices	3
(1) General Method	3
(a) Addition and Subtraction	3
(b) Integration	4
(c) The effect of amplifier gain on the accuracy of computation	4

* Since the original publication of this report in 1947 techniques and accuracy have been improved, methods of multiplying etc. have been developed and a large general purpose electronic differential analyser has been constructed at the Royal Aircraft Establishment.

LIST OF CONTENTS (contd.)

	<u>Page</u>
(d) The limits to the speed of electronic computation	5
(e) Practical Amplifiers	5
(ii) Cathode Followers	6
(iii) Step Circuits	7
III The Complete Analyser - the technique of setting up a differential equation and the calculation of the circuit constants	7
IV Test Problem	11
V Conclusions	12

LIST OF APPENDICES

	<u>Appendix</u>
A Detailed Study of the Adding Units	I
A Detailed Study of the Integrating Units	II
Calculation of the limits to the speed of electronic computation imposed by stray feedback components	III

LIST OF ILLUSTRATIONS

	<u>Fig.</u>
Basic Diagram of a Feedback Adding Unit	1
Basic Diagram of a Feedback Integrating Unit	2
Simplified Circuit Diagram of High Gain D.C. Amplifier as used in the American Mk.IX A.A. Predictor	3
Basic Diagram of a Simple Stabilising Unit	4
Circuit Diagram of T.R.E. Miniaturised D.C. Amplifier	5
Cathode follower	6
Step Circuit	7
Block Diagram of the Complete Analyser as used for solving a fifth order linear differential equation with constant coefficients	8
The Solutions to the Test Problem	9,10,11, 12,13
A single stage "sign-reversing" feedback amplifier	14
Overall characteristics of "sign-reversing" feedback amplifier showing dependence on the setting-up voltage X	15
Experimental characteristics of "sign-reversing" amplifier	16
Experimental characteristics of High Gain Summing Amplifier	17
Theoretical curves showing type of error obtained on integration of a D.C. voltage	18
Theoretical curves showing percentage error on integration of a D.C. voltage	19
Theoretical curves showing leading angle error on integration of a sinusoidal wave	20
The complete analyser	21

I. Introduction

Electronic analogy circuits have been used for some years now, mainly for simulation purposes, but the possibility of combining the different types into a flexible computing device of the differential analyser type does not seem to have been fully explored. Existing mechanical analysers are very accurate (better than 1 part in a thousand) but it is believed that an electronic analyser, while not achieving the same degree of accuracy, can offer considerable advantages over its mechanical counterpart. The parameters in an electronic device can be readily varied over very wide ranges and the rate at which the machine produces its solutions can also be varied greatly. In the field of high speed simulation, where very high rates of solution are required, electronic analogy circuits have already found wide applications. An electronic machine constructed mainly from readily obtainable radio components should have the advantage in cost of initial construction and of replacement of parts. It will also be comparatively smaller and more mobile.

To construct an analyser we require units which will perform the following mathematical operations:-

- (a) addition and subtraction
- (b) multiplication and division
- (c) integration and differentiation.

Addition and subtraction can readily be achieved electronically. Integration and differentiation can be performed with respect to time as a variable. Multiplication and division of two variables with regard to the appropriate sign of the result is the most difficult problem. Once this has been satisfactorily achieved the processes of integration and differentiation can readily be extended to operations with respect to variables other than time by using a multiplication process to change the variable into time.

II. The Component Computing Devices

(1) General Method

The basic unit in all the computing devices is a high gain (greater than 30,000 : 1) D.C. voltage amplifier containing an odd number of stages so that the sign of the output is opposite to that of the input. The linearity of amplification is not important but the higher the gain the more accurate is the whole computing device. In the appendices the accuracy of the computations is derived in terms of the gain of the amplifier and the types of error introduced are discussed. In the immediately following discussion the gain of the amplifiers are assumed to be infinite.

(a) Addition and subtraction

The basic diagram of a feedback adding unit is given in Fig.1.

The amplifier input terminal is directly connected to the grid of the first valve and as this has no grid leak once the stray capacitances of the valve and the wiring have been charged the amplifier draws no input current even if $E_g \neq 0$. Hence $I_1 = I_2$.

$$\text{i.e.} \quad \frac{E_g - E_o}{R_f} = \frac{E_1 - E_g}{R_1} + \frac{E_2 - E_g}{R_2} + \frac{E_3 - E_g}{R_3}$$

but $E_g = -\frac{E_o}{\mu} = 0$ if μ is assumed to be infinite, therefore

$$\frac{E_1}{R_1} + \frac{E_2}{R_2} + \frac{E_3}{R_3} = -\frac{E_o}{R_f}$$

Quantities can be subtracted readily by reversing the sign of the appropriate input voltage.

If we have only one input and $R_1 = R_f$ then $E_0 = - E_1$.

When so used we shall call the unit a "reversing amplifier".

(b) Integration

The basic diagram of a feedback integrating circuit is given in Fig.2.

As before $I_1 = I_2$ and $E_g = 0$ therefore

$$\frac{E_1}{R_1} = - C \frac{dE_0}{dt}$$

or
$$E_0 = - \frac{1}{R_1 C} \int E_1 dt.$$

(c) The effect of amplifier gain on the accuracy of computation

It is obvious that the above approximate calculations will only be valid if the gain of the amplifiers is so high that E_g is negligible in comparison with E_0 and E_1 . In the appendices to this report the calculations are carried out for the case of finite gain and the form of the errors introduced when μ is not infinite are discussed. The results obtained may be summarised as follows:-

In an adding unit of the above type the percentage error is given by

$$\left(1 + \frac{R_f}{R_1} + \frac{R_f}{R_2} + \frac{R_f}{R_3} + \dots \right) \frac{100}{\mu}$$

e.g. If the maximum value of R_f is 10 megohms and the minimum values of R_1, R_2, R_3 etc. are 0.1 megohm then to achieve 1% accuracy over this range of parameters an amplifier of gain at least equal to $n \times 10,000$ is required where n is the number of inputs.

For a "reversing amplifier" $R_1 = R_f, R_2 = R_3 = 0$. Therefore for 1% accuracy we require an amplifier of gain at least equal to 200.

In an integrating unit of the above type the total error is given by

$$\frac{1}{C R_1 (1 + \mu)} \int E_0 dt.$$

Thus if the polarity of E_0 is constant the error will increase with time. It is shown that the percentage error will be less than 1% provided t/CR is not allowed to become of order comparable with that of the gain, where t is the time in seconds during which the integration is performed.

If the polarity of E_0 is cyclic than the total error itself is cyclic. It is shown that the percentage error in this case will be less than 1% provided the ratio T/CR is not allowed to become comparable with the gain, where T is the period of the applied waveform.

(d) The limits to the speed of electronic computation

One of the main advantages of electronic analogue computers is their high speed of operation in comparison with mechanical or electro-mechanical computers. There is an upper limit to the speed of operation imposed however by the effects of stray leakages across critical components. These, in general, will introduce errors which will vary as the frequency of the analogue voltages varies.

The most critical point at which these "strays" may occur is across the input and output terminals of the high gain amplifiers. In an adding unit there will always be a certain amount of capacitive feedback due to stray capacities and in an integrating unit there will always be a certain amount of resistive feedback due to the condenser leakage resistance. Stray inductances should be of very small orders and are unlikely to introduce serious errors.

The effects of stray capacitive and resistive feedback currents in summing and integrating circuits respectively are calculated in Appendix III on the assumption that the gain of the amplifier used is infinite.

In the case of a summing amplifier where the feedback resistance is R_f ($= 5M\Omega$ say) and the stray capacity is assumed to be C ($= 10pF$ say) the effect of the stray capacity is to (1) delay the development of the solution by an exponential of time constant $R_f C$ secs ($= 50\mu$ secs) and (2) to introduce an amplitude and phase error in the case of an applied sinusoidal waveform. The amplitude and phase errors both increase with the frequency of the applied waveform. For the component values of R_f and C quoted above a 1% error in amplitude will be developed when the frequency is 450 cycles/sec and at this frequency the phase error is 8° . If R_f had been $0.1M\Omega$ then the upper frequency limit would have been 22.5 Kc/sec and the phase error $9'$.

In integrating units it is shown that equivalent performances can be obtained by using (1) an amplifier of infinite gain, an input resistor R_1 and a feedback condenser C with leakage resistance R_f or (2) an amplifier of finite gain $= R_f/R_1$, an input resistor R_1 and a feedback condenser C with an infinite leakage resistance.

The conclusions reached in Appendix II therefore still apply if we replace μ by R_f/R_1 when R_f/R_1 is less than μ .

(e) Practical Amplifiers

Single stage amplifiers with gains of the order of 70 or 80 have been tried but have proved very inaccurate as would be expected on the above theory. Three stage amplifiers with gains of the order of 30,000 or 100,000 are now being used. Because of the feedback circuits used in the computing circuits these amplifiers are extremely stable.

In the analyser described later in this report the D.C. amplifiers used had gains of 30,000 or more. To reverse the sign of certain quantities low gain (70 or 80) amplifiers are used but it is proposed to replace these by high gain amplifiers. The low gain amplifiers used are described in Appendix I mainly to show up the limitations of such amplifiers.

Fig.3 is a simplified circuit diagram of the high gain D.C. amplifier as used for computing in the American Mk.9 Predictor. The integrating units of the analyser employ amplifiers of this type. Important points about this amplifier are:-

(a) To counteract random voltage effects due to variations of electron emission from the cathode of the first stage of the amplifier a special circuit employing a twin-triode is used. If the resistance $R = 1/G_m$, where G_m is the transconductance of the valve, any random voltages due to variations in emission have no effect in producing a voltage drop across the cathode load and hence the grid-cathode potential is unaffected by these random voltages.

(b) The output stage is so designed that the amplifier can be set so that it gives zero output for zero input.

A British equivalent of this amplifier is being produced. It has a similar performance to the American amplifier but employs a different method of stabilisation and is somewhat easier to set up for the input network of the American amplifier acts as a load across the input and hence the setting is dependent on the input circuit.

Both of these amplifiers will operate over wide ranges of voltages (+100 to -100 volts output). Their main disadvantage is that they require five different D.C. supply voltages which have to be stabilised and moreover as the output stages are power valves they consume a lot of power. The analyser described requires about 1 kilowatt of power for operation.

Fig.4 gives the basic diagram of a simple stabilising unit which effectively deals with the stabilised voltage supply problem. When fed from a smoothed conventional power unit of some 500V. D.C. it gives an output voltage V_o where $KV_o = E_o$. An upper voltage limit of 400V. is imposed on V_o due to the need for some 100V. across the series valves and a lower limit of E_o since $K < 1$. E_o is normally equal to 120V. - there is little point in using a lower value as the amplifier valve would then have to operate with a very low anode voltage. Effectively therefore we can obtain output voltages within the range 120 - 400V. An inverted unit will cover -400 to -120V. and a combination of a positive and negative unit will cover the range -120V - 0 - +120V. The degree to which stabilisation is effective is better than 1% per 100 mA of output current over the complete range of operation.

A miniature D.C. amplifier for similar computing circuits used in simulator problems has been designed at T.R.E. and is now in production (Fig.5). This amplifier which requires only two stabilised D.C. voltages at low power levels, has a gain of the order of 100,000. The range of voltage operation is smaller but for most purposes this is not important. When these amplifiers are available the construction of computing devices will be much easier. The summing circuit of the analyser uses one of these amplifiers.

(ii) Cathode Followers

Some form of impedance transforming device is essential as an interlink between the computing devices. A simple cathode follower which has the properties of high input impedance and low output terminal impedance is ideal for this device. Being a degenerative amplifier it is capable of handling wide ranges of input voltages without overloading. The only question which requires careful consideration is that of the effective overall gain of the device and its variations over the range of operation.

Fig.6 shows a typical cathode follower as used as an interlink. It is designed so that it may be adjusted to give zero output for zero input. The mean amplification factor determined for several different cathode followers all with the same nominal values of components was found to be 0.966 ± 0.016 . The value of 0.966 has been taken for the amplification factor of the cathode followers throughout the analyser.

The necessity for having cathode follower interlinks in the analyser would be greatly simplified if each stage were constructed with a cathode follower output and any feedback loops connected from the output of the cathode follower back to the input of the stage. This would simplify setting up procedure and avoid the repeated appearance of the 0.966 constant in the calculations for the analyser equation.

(iii) Step Circuits

In order to inject into the analyser required initial conditions we require a unit which will add to any voltage passing through it a constant positive or negative predetermined D.C. voltage.

A simple circuit which will achieve this objective is given in Fig.7.

With the switch S closed R_1 is adjusted until $V_1 = V_0 = 0$. When S is opened V_0 is stepped above or below V_1 by an amount depending on the setting of R_2 say $\pm E$. Thus

$$V_0 = \beta V_1 \pm E.$$

Over the range of voltages used β is substantially constant, e.g. if

$$\begin{aligned} E = 2V, \beta &= 0.884 \\ E = 5V, \beta &= 0.880 \\ E = 10V, \beta &= 0.870. \end{aligned}$$

The mean value of $\beta = 0.878$ is used throughout the analyser calculations.

III. The Complete Analyser

It has been shown that we can add, subtract and integrate and differentiate with respect to time by electronic methods with an average error of at most 1%. Lacking units which will effectively multiply D.C. voltages to the same order of accuracy we are far short of having a complete differential analyser but nevertheless certain types of differential equations can be solved using these circuits. In particular we can solve linear differential equations with constant coefficients taking the independent variable as time. As this is a type of equation occurring frequently in physical problems the apparatus should prove a useful tool for investigating such problems when a high degree of accuracy is not required.

The present apparatus consists of:-

- (a) five integrators employing amplifiers of gain 30,000 : 1
- (b) one summing circuit employing an amplifier of gain 100,000 : 1
- (c) three "reversing amplifiers" employing simple single stage amplifiers of gain 70 : 1
- (d) six cathode followers for use as buffer stages
- (e) five "step circuits" for introducing initial conditions into the differential equation
- (f) a bank of fifteen relays controlled by a master switch
- (g) ten cathode followers with meters in their outputs for observing the variables as they are developed in the analyser

- (h) two recording meters for the recording of the results - for the recording of rapidly varying quantities a cathode ray tube and camera or high speed optical oscilloscope may be used.

All the above units are provided with plugs and sockets so that they may be interconnected in any desired fashion somewhat like a telephone switchboard (See Fig.21).

Calibration dials enable the time constants of the integrators to be set to any value within the range 0.1 to 10 secs and the resistance arms of the summing circuit to any value within the range 0.1 to 10 megohms.

To illustrate the technique of interconnecting the units and setting up a desired equation consider the following example. It is desired to set up and solve the equation

$$\overset{\cdot\cdot\cdot\cdot}{x} + a \overset{\cdot\cdot\cdot}{x} + b \overset{\cdot\cdot}{x} + c \overset{\cdot}{x} + dx + ex = 0 \quad (1)$$

for the initial conditions

$$x = \text{constant}, \overset{\cdot}{x} = \overset{\cdot\cdot}{x} = \overset{\cdot\cdot\cdot}{x} = \overset{\cdot\cdot\cdot\cdot}{x} = 0$$

Fig.8 is a block schematic diagram showing how the analyser is connected up to solve this problem.

Assuming the voltage V_1 to be proportional to $\overset{\cdot\cdot\cdot\cdot}{x}$ then successive integrations along the main chain will give V_2, V_3, V_4, V_5, V_6 , proportional to $\overset{\cdot\cdot\cdot}{x}, \overset{\cdot\cdot}{x}, \overset{\cdot}{x}, x, -x$. These voltages are all fed back to the input of the summing circuit and when added together in the proper proportions they will define the voltage V_1 which is proportional to $\overset{\cdot\cdot\cdot\cdot}{x}$. The whole system is thus a closed loop and at all times x and its time derivatives must satisfy the equation defined by the system. In Fig.8 it has been assumed that all the coefficients a, b, c, d, e , are positive and hence any derivatives which are opposite in sign to V_1 are reversed in sign before being fed back to the summing amplifier. In the present apparatus it is not necessary to have cathode follower interlinks in the main chain as each of the units in this chain either have power output stages or have cathode followers built into the units.

In closing the loops random initial conditions will be set up and from the instant the last link is closed x and its time derivatives satisfy the equation with these random initial conditions. What happens consequently depends on the nature of the solutions. If they are say damped oscillations the analogy voltages will eventually all settle down to zero. If they are increasing quantities with time when eventually one of the stages will reach its limit of operation and the equation breaks down. Now in order to inject specific initial conditions we close all the loops simultaneously under predicted conditions with x and its time-derivatives all at predetermined values. This is achieved by having relays in all the interconnecting leads (not shown in the diagram) and arranged so that the input to every stage is zero and its output (adjusted on the stage controls) also at zero. In the appropriate connecting leads we insert "step circuits" when initial conditions other than zero are required. When a master switch is thrown all the relays operate and the initial conditions are then those defined by the "step-circuits". In this way solutions to equations may be obtained whether or not the variables increase or decrease with time. When they are increasing with time the solution of course breaks down whenever a particular stage reaches its limit of operation.

If the function (1) is not equal to zero but equal to a function $f(t)$ of time this function may be inserted at the point A of the summing network.

Calculation of the Circuit Constants:-

$$\text{Let } V_1 = a_1 \ddot{x}$$

$$V_2 = -a_2 \dot{x}$$

$$V_3 = a_3 \dot{x}$$

$$V_4 = -a_4 \dot{x}$$

$$V_5 = a_5 \dot{x}$$

$$V_6 = -a_6 x$$

For the integrators:-

Input voltage = - (time constant of integration) $\frac{d(\text{output voltage})}{dt}$

$$\text{e.g. } V_1 = -R_1 C_1 \frac{dV_2}{dt}$$

$$\text{i.e. } a_1 = R_1 C_1 \cdot a_2$$

$$\text{or } a_1/a_2 = R_1 C_1.$$

Similarly

$$\frac{a_1}{a_2} = R_1 C_1 = T_1 \text{ say}$$

$$\frac{a_2}{a_3} = R_2 C_2 = T_2 \text{ "}$$

$$\frac{a_3}{a_4} = R_3 C_3 = T_3 \text{ "}$$

$$\frac{a_4}{a_5} = R_4 C_4 = T_4 \text{ "}$$

$$\frac{a_5}{a_6} = R_5 C_5 = T_5 \text{ "}$$

At the summing amplifier grid:-

$$-\frac{\alpha V_6}{R_1} + \frac{\alpha V_5}{R_2} - \frac{\alpha V_4}{R_3} + \frac{\alpha V_3}{R_4} - \frac{\alpha V_2}{R_5} = -\frac{V_1}{R_f}$$

$$\text{i.e. } \frac{\alpha a_6}{R_1} x + \frac{\alpha a_5}{R_2} \dot{x} + \frac{\alpha a_4}{R_3} \ddot{x} + \frac{\alpha a_3}{R_4} \ddot{x} + \frac{\alpha a_2}{R_5} \ddot{x} + \frac{a_1}{R_f} \ddot{x} = 0$$

Hence the given equation will be solved providing

$$a = \alpha \cdot \frac{a_2}{a_1} \cdot \frac{R_f}{R_5}$$

$$b = \alpha \cdot \frac{a_3}{a_1} \cdot \frac{R_f}{R_4}$$

$$c = \alpha \cdot \frac{a_4}{a_1} \cdot \frac{R_f}{R_3}$$

$$d = \alpha \cdot \frac{a_5}{a_1} \cdot \frac{R_f}{R_2}$$

$$e = \alpha\beta \cdot \frac{a_6}{a_1} \cdot \frac{R_f}{R_1}$$

i.e. if

$$a = \alpha \cdot \frac{1}{T_1} \cdot \frac{R_f}{R_5}$$

$$b = \alpha \cdot \frac{1}{T_1 T_2} \cdot \frac{R_f}{R_4}$$

$$c = \alpha \cdot \frac{1}{T_1 T_2 T_3} \cdot \frac{R_f}{R_3}$$

$$d = \alpha \cdot \frac{1}{T_1 T_2 T_3 T_4} \cdot \frac{R_f}{R_2}$$

$$e = \alpha\beta \cdot \frac{1}{T_1 T_2 T_3 T_4 T_5} \cdot \frac{R_f}{R_1}$$

Now α , the cathode follower constant = 0.966

β , the step circuit constant = 0.878

and the T's and R's can be set over wide ranges on the calibrated dials, hence the equation may be set up for a very wide range of coefficients.

The arrangement above will produce a solution which will vary in true relationship to the time in seconds. For some solutions this may be inconvenient as the solution may vary too rapidly or too slowly for easy recording. By a suitable change of the independent variable however the "time scale" of the solution may be extended or contracted at will. If the time scale is defined by the constant λ where

$$(\text{true time}) = \frac{(\text{time scale of analyser})}{\lambda}$$

then the above formulae become:-

$$a = \alpha \cdot \frac{\lambda}{T_1} \cdot \frac{R_f}{R_5}$$

$$b = \alpha \cdot \frac{\lambda^2}{T_1 T_2} \cdot \frac{R_f}{R_4}$$

$$c = \alpha \cdot \frac{\lambda^3}{T_1 T_2 T_3} \cdot \frac{R_f}{R_3}$$

$$d = \alpha \cdot \frac{\lambda^4}{T_1 T_2 T_3 T_4} \cdot \frac{R_f}{R_2}$$

$$e = \alpha \cdot \frac{\lambda^5}{T_1 T_2 T_3 T_4 T_5} \cdot \frac{R_f}{R_1}$$

e.g. if $\lambda = 1/10$ the solution will vary with time at 10 times the true rate.

Alteration of the "rate of solution" of the analyser is therefore merely a case of multiplying or dividing all the time constants by a fixed amount.

In using the analyser therefore a convenient method would seem to be the following:- set all the time constants to say 5 secs and set up the a, b, c, d, e, coefficients merely by adjusting the arms of the summing network. A trial run will show whether or not a convenient rate of solution has been achieved. If not reset the time constants to 10 secs or 1 sec according to whether a slower or more rapid solution is required. To enable this variation of rate of solution to be controlled with the minimum of effort the "time-constant calibrated dials" have been specially marked at the 1, 5 and 10 second levels.

The only things now to be determined are the amplitude scale factors of the recorded results. The range of variation of x can be set arbitrarily as it is purely a function of the initial conditions for x. Suppose we make $a_6 = 1$ then x will be recorded on a scale of 1 volt per unit of x. The scales for the time-derivatives are then seen to be

$$\begin{aligned}
 a_5 &= \frac{T_5}{\lambda} && \text{volts per unit of } \dot{x} \\
 a_4 &= \frac{T_5 T_4}{\lambda^2} && \text{" " " " } \ddot{x} \\
 a_3 &= \frac{T_5 T_4 T_3}{\lambda^3} && \text{" " " " } \dddot{x} \\
 a_2 &= \frac{T_5 T_4 T_3 T_2}{\lambda^4} && \text{" " " " } \dots \\
 a_1 &= \frac{T_5 T_4 T_3 T_2 T_1}{\lambda^5} && \text{" " " " } \dots
 \end{aligned}$$

The recording meters provided are centre zero instruments with full scale deflections adjustable in twelve steps between $\frac{2}{3}$ volt and 125 volts and this may be extended upwards if necessary.

IV. Test Problem

The following test problem has been solved with a view to determining the overall accuracy of the analyser.

Solve the equation

$$\dddot{x} + (0.1671) \ddot{x} + (0.0460) \dot{x} + (0.00474) x + (0.000330) x = 0$$

for the initial conditions $x = \text{constant}$, $\ddot{x} = \dot{x} = x = 0$.

The analyser was set up exactly as in the previous discussion, except that only four integrators were used.

We have therefore

$$a = 0.1671 = \alpha \cdot \frac{\lambda}{T_1} \cdot \frac{R_f}{R^1_4}$$

$$b = 0.0460 = \alpha \cdot \frac{\lambda^2}{T_1 T_2} \cdot \frac{R_f}{R^1_3}$$

$$c = 0.00474 = \alpha \cdot \frac{\lambda^3}{T_1 T_2 T_3} \cdot \frac{R_f}{R^1_2}$$

$$d = 0.000330 = \alpha \beta \cdot \frac{\lambda^4}{T_1 T_2 T_3 T_4} \cdot \frac{R_f}{R^1_1}$$

The pattern for rapidly determining appropriate T's and λ's had not been thought out at the time of applying the test solution and the actual values used were:-

$$\begin{aligned} \lambda &= 1 \\ T_1 &= T_2 = T_3 = T_4 = 10 \text{ secs} \\ R_f &= 4.578 \text{ megohms} \\ R'_4 &= 2,864 \text{ " } \\ R'_3 &= 0.975 \text{ " } \\ R'_2 &= 0.947 \text{ " } \\ R'_1 &= 1.194 \text{ " } \end{aligned}$$

With an initial condition of $x = 12.6$ units the following scale factors were used

$$\begin{aligned} a_5 &= 1 &= & 1 \text{ volts per unit of } x \\ a_4 &= T_4 &= & 10 \text{ " " " " } \dot{x} \\ a_3 &= T_4 T_3 &= & 100 \text{ " " " " } \ddot{x} \\ a_2 &= T_4 T_3 T_2 &= & 1,000 \text{ " " " " } \dddot{x} \\ a_1 &= T_4 T_3 T_2 T_1 &= & 10,000 \text{ " " " " } \dots x \end{aligned}$$

Figs. 9, 10, 11, 12, 13, show the solutions obtained. The dots along the curves are the theoretical values calculated by the Assessment Division of Guided Weapons Dept.

V. Conclusions

Theoretically using very high gain amplifiers and good quality components high degrees of accuracy can be achieved. The practical limits in achieving these high accuracy figures would seem to be in the components and a very careful engineering design of the calibrating system etc.

The results obtained with the present analyser although poor in accuracy show considerable promise especially as two of the reversing amplifiers used were of the low gain type. It is considered that considerable improvement could be made by replacement of these units by high-gain reversing amplifiers and by a more careful calibration of the integrators and summing amplifiers. At present only normal radio components have been used and it is suspected that temperature drifts in values etc. are having a detrimental effect. As the present accuracy is considered sufficient for the immediate problems to be given to the analyser and as any considerable improvement would require the analyser to be rebuilt using high grade components little further work will be done until at least a satisfactory method of multiplying has been developed.

APPENDIX I

A Detailed Study of the Adding Units

In the basic diagram of Fig. 1, $I_1 = I_2$

$$\frac{E_g - E_o}{R_f} = \frac{E_1 - E_g}{R_1} + \frac{E_2 - E_g}{R_2} + \frac{E_3 - E_g}{R_3}$$

Now $E_g = -\frac{E_o}{\mu}$

therefore

$$\frac{E_1}{R_1} + \frac{E_2}{R_2} + \frac{E_3}{R_3} = -\frac{E_o}{R_f} - \frac{E_o}{\mu} \left[\frac{1}{R_f} + \frac{1}{R_1} + \frac{1}{R_2} + \frac{1}{R_3} \right]$$

The last term on the right hand side of this equation is the "error term" and it shows that the error is inversely proportional to the gain of the amplifier. In fact the percentage error is given by

$$\left(1 + \frac{R_f}{R_1} + \frac{R_f}{R_2} + \dots + \frac{R_f}{R_n} \right) \frac{100}{\mu}$$

when there are n inputs. Thus in general the more inputs there are and the greater the ratio of feedback to input resistors the greater is the percentage error for a given amplification.

In the summing circuit of the analyser we have five inputs the resistors of which may be adjusted over the range 0.1 to 10 megohms and the feedback resistor may be adjusted over the range 0.1 to 10 megohms also thus under the least favourable conditions the percentage error is given by

$$\left[1 + 5 \left(\frac{10}{0.1} \right) \right] \frac{100}{\mu} = \frac{50,000}{\mu}$$

Therefore to maintain an error of less than 1% under such conditions we require an amplifier whose gain is at least 50,000. The amplifier used has a gain of 100,000.

For a "reversing amplifier" we have one input with $R_1 = R_f$, the percentage accuracy in this case is therefore given by

$$\frac{200}{\mu}$$

The amplifiers used for this purpose in the analyser are single stage amplifiers and the gain will not exceed 100 so that the error is at least 2%. This it would seem is one of the main sources of error in the present analyser.

To investigate this point more fully consider the actual circuit used, Fig. 14.

Let the input resistor be R and the feedback resistor aR where $a = 1$. If I_a increases by δi_a milliamps then the grid-cathode potential must increase by $\frac{\delta i_a}{g}$ volts. The auto-grid-bias increases by $\frac{1}{2} \delta i_a$ volts. Therefore the grid-earth potential must increase by $\delta i_a \left(\frac{1}{2} + \frac{1}{g} \right)$ volts = δV_g volts. The anode volts fall by $70 \delta i_a$ volts therefore the output falls by $+\frac{22}{50} \times 70 \delta i_a = +31 \delta i_a = -\delta V_o$ volts.

Now $V_g = \frac{aV_1 + V_o}{a + 1}$ volts but $a \approx 1$ and $V_1 \approx -V_o$

hence $V_g \approx \frac{aV_1 + V_o}{2}$

or $2\delta i_a \left(\frac{1}{2} + \frac{1}{g}\right) = a\delta V_1 - 31\delta i_a$

$$\therefore a\delta V_1 = \delta i_a \left(32 + \frac{2}{g}\right)$$

$$\therefore \frac{\delta V_o}{\delta V_1} = \frac{-31}{32 + \frac{2}{g}} \cdot \frac{1}{a}$$

$$\therefore V_o = \frac{-31}{32 + \frac{2}{g}} \cdot \frac{1}{a} \cdot V_1 + \text{Constant} \quad (\text{Assuming } g \text{ to be constant.})$$

The unit is set up by adjusting the screen voltage until when $V_1 = 0$, V_o is also zero. Under these conditions the above constant = 0 and we have

$$V_o = \frac{-31}{32 + \frac{2}{g}} \cdot \frac{1}{a} \cdot V_1$$

The overall gain of the unit is therefore not $-1/a$ but is always somewhat smaller and as g is not constant the gain will vary as g varies.

One method of setting up the unit is as follows. Put $V_1 = -X$ volts say, and adjust the feedback resistor until $V_o = +X$ volts, i.e. we

choose a so that $\frac{-31}{32 + \frac{2}{g}} \cdot \frac{1}{a} = -1$ for one particular input voltage.

Depending on the size of X we get variations in the form of the overall characteristic of the unit. (See Fig.15.) The curves diverge rapidly from the ideal when g falls off rapidly in one direction and when the anode voltage falls below the screen voltage in the other. Thus in addition to the limited accuracy we also have a limited range of operation. Fig.16 shows experimental curves of the type shown in Fig.15. Fig.17 shows curves obtained using a high gain amplifier - the range of operation and linearity are obviously much higher.

APPENDIX II

A Detailed Study of the Integrating Units

In the basic diagram of Fig. 2, $I_1 = I_2$ (1)

Now $I_1 = \frac{E_1 - E_g}{R}$ (2)

and $E_g - E_o = \frac{1}{C} \int I_2 dt$ (3)

therefore integrating (1) and inserting the values of I_1 and I_2 given by (2) and (3) we see that

$$\int \frac{E_1 - E_g}{R} dt = C (E_g - E_o)$$

but $E_o = - E_g$

therefore $\int \frac{E_1 + \frac{E_o}{\mu}}{R} dt = -CE_o(1 + \frac{1}{\mu})$

or $E_o = \frac{-\mu}{CR(1 + \mu)} \int E_1 dt - \frac{1}{CR(1 + \mu)} \int E_o dt$ (4)

The first term on the right hand side of this equation is the required solution. The second term is the error term. As $\mu \rightarrow \infty$ (4) becomes

$$E_o = - \frac{1}{CR} \int E_1 dt$$

and this is the relationship normally assumed for such integrating units.

Since the error is proportional to $\int E_o dt$ if the polarity of E_o is constant the error will increase with time. In this case higher accuracy is achieved by integrating over a shorter period of time. If the polarity of E_o is cyclic then the error itself is cyclic. Consider now two special cases in which the error term may be readily evaluated: - firstly when E_1 is a constant voltage and secondly when it is sinusoidal.

Case (1). If $E_1 = \text{constant} = V$ then

$$E_o = \frac{-\mu V t}{CR(1 + \mu)} - \frac{1}{CR(1 + \mu)} \int E_o dt$$

A solution of this equation is given by

$$E_o = A e^{\frac{-t}{CR(1 + \mu)}} - \mu V \text{ where } A \text{ is arbitrary.}$$

If for $t = 0$, $E_0 = 0$ then $A = \mu V$ and

$$E_0 = \mu V \left[1 - e^{-\frac{t}{CR(1+\mu)}} \right]$$

The desired solution is

$$E_0 = -\frac{Vt}{CR}$$

The form of the error between these for various values of μ is shown in Fig.18.

Expressed as a percentage the error is given by

$$100 \left[1 - \frac{\mu CR}{t} \left(1 - e^{-\frac{t}{CR(1+\mu)}} \right) \right]$$

and this percentage error as a function of μ for various t/CR ratios is shown in Fig.19.

It is seen from these curves that with a high gain amplifier [$\mu \geq 30,000$] that the percentage error is very small unless one has very high ratios of t/CR .

Case (2). If $E_1 = \lambda \sin wt$ then

$$E_0 = \frac{\mu}{CR(1+\mu)} \int \lambda \sin wt \cdot dt - \frac{1}{CR(1+\mu)} \int E_0 dt$$

A solution of this equation is

$$E_0 = B e^{-\frac{t}{a}} + \frac{\mu\lambda}{a} \cdot \frac{1}{\sqrt{w^2 + \frac{1}{a^2}}} \cdot \cos(wt + \phi)$$

$$\text{where } a = CR(1 + \mu)$$

$$\phi = \tan^{-1} \frac{1}{aw}$$

$B =$ arbitrary constant

If initially at $t = 0$, $E_0 = 0$ then

$$B = -\frac{\mu Aw}{a(w^2 + \frac{1}{a^2})}$$

and

$$E_0 = \frac{-\mu\lambda w}{a(w^2 + \frac{1}{a^2})} e^{-\frac{t}{a}} + \frac{\mu\lambda}{a} \cdot \frac{1}{\sqrt{w^2 + \frac{1}{a^2}}} \cos(wt + \phi)$$

or

$$E_0 = \frac{\mu\lambda}{a\sqrt{w^2 + \frac{1}{a^2}}} \left[\cos(wt + \phi) - \frac{w}{\sqrt{w^2 + \frac{1}{a^2}}} e^{-\frac{t}{a}} \right]$$

The desired solution is

$$E_0 = \frac{\mu\lambda}{aw} \left[\cos wt - 1 \right]$$

The solution as given by the integrator is seen therefore to be erroneous in three aspects.

(1) The overall amplitude is too small by a factor of $\frac{w}{\sqrt{w^2 + \frac{1}{a^2}}}$.

(2) The cosine term is leading the true solution by an angle ϕ where $\phi = \tan^{-1} \frac{1}{aw}$.

(3) There is an exponential drift in the solution given by

$$\left(1 - \frac{w}{\sqrt{w^2 + \frac{1}{a^2}}} \right) \cdot e^{-\frac{t}{a}}$$

As is to be expected each of these errors tends to zero as $\mu \rightarrow \infty$.

Considering these errors in turn:-

(1) The overall amplitude error is less than 1% if

$$\frac{w}{\sqrt{w^2 + \frac{1}{a^2}}} > 0.99$$

and as $a = CR(1 + \mu)$

$w = \frac{2\pi}{T}$ where T is the period of the input, we see that this error is less than 1% if

$$1 + \mu > (1.1) \frac{T}{CR}$$

(2) The constant angle of lead of the cosine term is shown in Fig.20 for several T/CR ratios, as a function of μ .

(3) If the exponential drift amounts to 1% then

$$\frac{w}{\sqrt{w^2 + \frac{1}{a^2}}} \cdot e^{-\frac{t}{a}} = 0.99$$

Now if $1 + \mu > (1.1) \frac{T}{CR}$ we have seen that

$$1 > \frac{w}{\sqrt{w^2 + \frac{1}{a^2}}} > 0.99$$

$$\therefore 1 > 0.99 e^{t/a} > 0.99$$

$$\therefore 1.01 > e^{t/a} > 1$$

$$\therefore 0 < \frac{t}{a} < \log_e 1.01$$

i.e. for a drift error of less than 1%, $E < 100a = 100 CR(1 + \mu)$

$$\text{i.e. } 1 + \mu > 100 \frac{t}{CR}$$

In conclusion it may be said that using an amplifier of high gain ($\mu > 30,000$) the accuracy of integration is good and in all cases will be better than 1% provided the ratios $\frac{T}{CR}$ and $\frac{100 t}{CR}$ are not allowed to become of comparable order to that of the gain.

APPENDIX III

Calculation of the Limits to the Speed of Electronic Computation Imposed by Stray Feedback Components.

The effects of stray feedback currents round a high gain amplifier computer can be readily evaluated on the assumption that the gain is infinite. The effects of finite gain will introduce further errors similar to those discussed under Appendices I and II.

If in Fig.2 we replace C by C and R_f in parallel, and make $\mu = \infty$ we see that

$$E_o = - \frac{R_f}{R_1} E_1 - R_f C \frac{dE_o}{dt} \quad (1)$$

As before consider the two typical cases

(1) $E_1 = \text{constant} = V$

(2) $E_1 = \lambda \sin \omega t$

Case (1). $E_1 = V$

A solution of equation (1) is given by

$$E_o = - \frac{R_f}{R_1} V + A e^{-\frac{t}{R_f C}} \quad \text{where } A \text{ is arbitrary.}$$

If for $t = 0$, $E_o = 0$ then $A = \frac{R_f}{R_1} V$ and

$$E_o = - \frac{R_f}{R_1} \left[V - V e^{-\frac{t}{R_f C}} \right]$$

- (a) In an ideal adding computer R_f is a large resistor (say 5 M Ω) and $C = 0$, giving

$$E_o = - \frac{R_f}{R_1} V.$$

The effect of a small stray capacity C (say 10pF) is therefore to introduce a time-lag in the development of the true solution. The time constant of this lag is $R_f C$ (= 50 μ secs for the values of R_f and C given above).

- (b) In an ideal integrating computer C is a large capacitor (say 1 μ F) and $R_f \rightarrow \infty$ giving (on expansion of the exponential term)

$$E_o \rightarrow \frac{Vt}{CR_1}.$$

The effect of a leakage resistance across the integrating capacity is seen to produce an effect similar to that produced by a perfect capacity across an amplifier of finite gain. In Appendix II, Case (1), it was shown that when $R_f = \infty$, gain = μ , that

$$E_o = - \mu V \left[1 - e^{-\frac{t}{CR(1 + \mu)}} \right].$$

Therefore if $\mu + 1 = \mu$ the effect of the leakage resistance is equivalent to a reduction in gain of the amplifier from ∞ to R_f/R_1 . Normal condensers have a scheduled time constant of at least 2000 megohm-microfarads - i.e. for a $1\mu F$ condenser the leakage resistance is at least 2000 megohms. High quality condensers with higher leakage resistances are therefore to be strongly recommended for integrating purposes.

Case (2). $E_1 = \lambda \sin wt$.

A solution to equation (1) is given by

$$E_0 = -\frac{R_f}{R_1} \cdot \frac{\lambda}{1 + w^2 R_f^2 C^2} (\sin wt - w R_f C \cos wt) + A e^{-\frac{t}{R_f C}}$$

where A is arbitrary.

If for $t = 0$, $E_0 = 0$ then $A = -\frac{R_f}{R_1} \cdot \frac{\lambda}{1 + w^2 R_f^2 C^2} \cdot w R_f C$ and

$$E_0 = -\frac{R_f}{R_1} \cdot \frac{\lambda}{1 + w^2 R_f^2 C^2} \left[w R_f C e^{-\frac{t}{R_f C}} + \sin wt - w R_f C \cos wt \right]$$

- (a) In an ideal adding computer R_f is a large resistor (say $5 M\Omega$) and $C = 0$, giving

$$E_0 = -\frac{R_f}{R_1} \cdot \lambda \sin wt$$

The effect of a small stray capacity C (say $10pF$) is therefore to introduce an initial transitory period of time constant $R_f C = 50 \mu sec$ after which the output is given by

$$E_0 = -\frac{R_f}{R_1} \cdot \frac{\lambda}{1 + w^2 R_f^2 C^2} \left[\sin wt - w R_f C \cos wt \right]$$

i.e. $E_0 = -\frac{R_f}{R_1} \cdot \frac{\lambda}{\sqrt{1 + w^2 R_f^2 C^2}} \cdot \sin (wt - \tan^{-1} w R_f C)$

The output sine-wave has therefore an error in amplitude and an error in phase.

The amplitude error increases with frequency and will amount to 1% of the true amplitude when

$$\sqrt{1 + w^2 R_f^2 C^2} = \frac{100}{99}$$

The error therefore exceeds 1% if the frequency rises above

$$f = \frac{1}{R_f C} \cdot \frac{1}{\pi} \cdot \frac{1}{\sqrt{200}} \quad \text{for } \left. \begin{array}{l} R_f = 5 \text{ megohms} \\ C = 10 \text{ pF} \end{array} \right\}$$

$$f = 450 \text{ cycles/sec}$$

The phase error also increases with frequency and at 450 cycles/sec it is 8° .

- (b) In an ideal integrating computer C is a large capacitor (say $1\mu F$) and $R_f \rightarrow \infty$ giving

$$E_0 = +\frac{\lambda}{w R_1 C} (\cos wt - 1)$$

When the leakage resistance is taken into account the solution may be put in the form

$$E_o = \frac{R_f}{R_1} \cdot \frac{\lambda}{\sqrt{1 + w^2 R_f^2 C^2}} \left[\cos\left(wt + \tan^{-1} \frac{1}{w R_f C} \right) - \frac{w R_f C}{\sqrt{1 + w^2 R_f^2 C^2}} e^{-\frac{t}{R_f C}} \right]$$

Again it is seen by comparison with the results obtained in Appendix II, Case (2), viz.

$$E_o = \frac{\mu \lambda}{a \sqrt{w^2 + \frac{1}{a^2}}} \left[\cos\left(wt + \tan^{-1} \frac{1}{aw} \right) - \frac{w}{\sqrt{w^2 + \frac{1}{a^2}}} e^{-\frac{t}{a}} \right]$$

where $a = CR(1 + \mu)$ $R_f = \infty$, gain = μ ,

that if $\mu + 1 = \mu$ then the effect of the leakage resistance is equivalent to a reduction in gain of the amplifier from ∞ to R_f/R_1 .

Thus, for a given accuracy of computation, the effect of stray capacity in an adding unit is to impose an upper frequency limit, and the effect of leakage resistance in an integrating unit is similar to the effect of finite amplifier gain in that it imposes a limit to the time over which a D.C. voltage may be integrated.



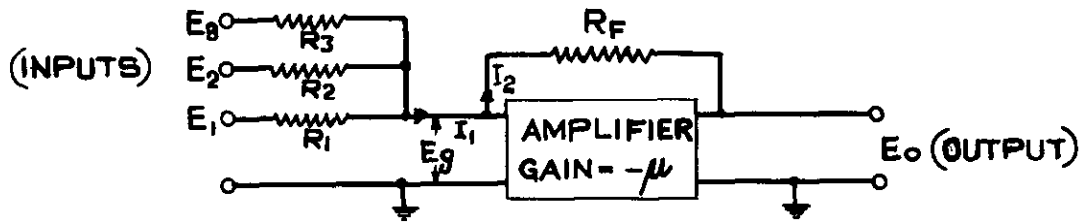

FIG.1
 BASIC DIAGRAM OF A FEEDBACK
 ADDING UNIT.

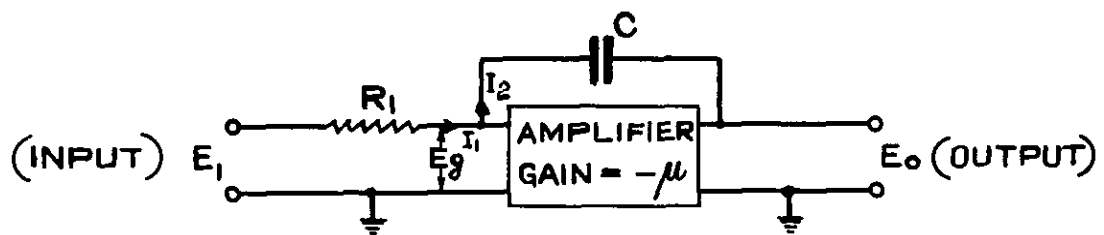

FIG.2
 BASIC DIAGRAM OF A FEEDBACK
 INTEGRATING UNIT.

2

4

2

4

5

4

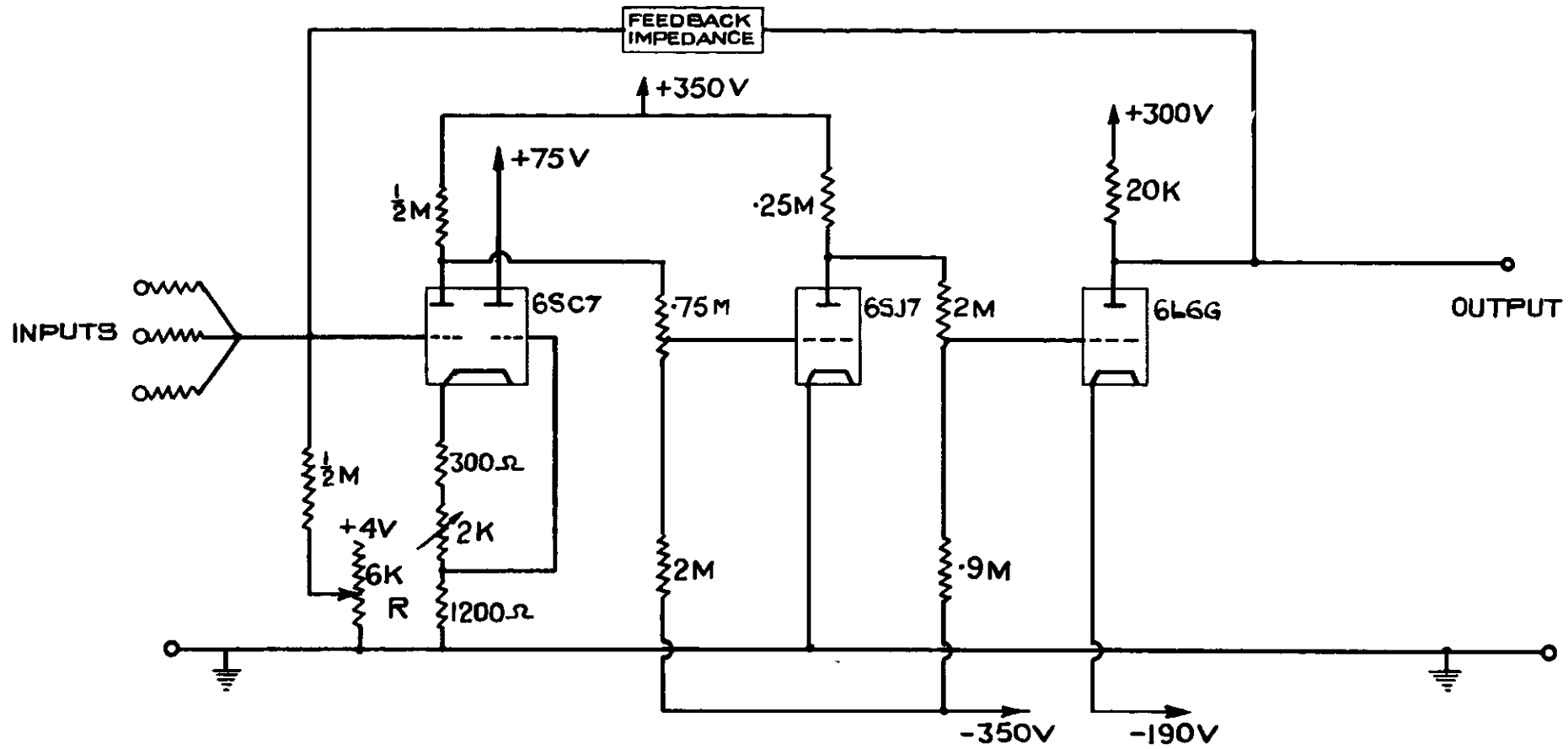

FIG.3
 SIMPLIFIED CIRCUIT DIAGRAM OF HIGH-GAIN D.C. AMPLIFIER
 AS USED IN AMERICAN MK. IX A-A-PREDICTOR.

5

4

4

3

2

1

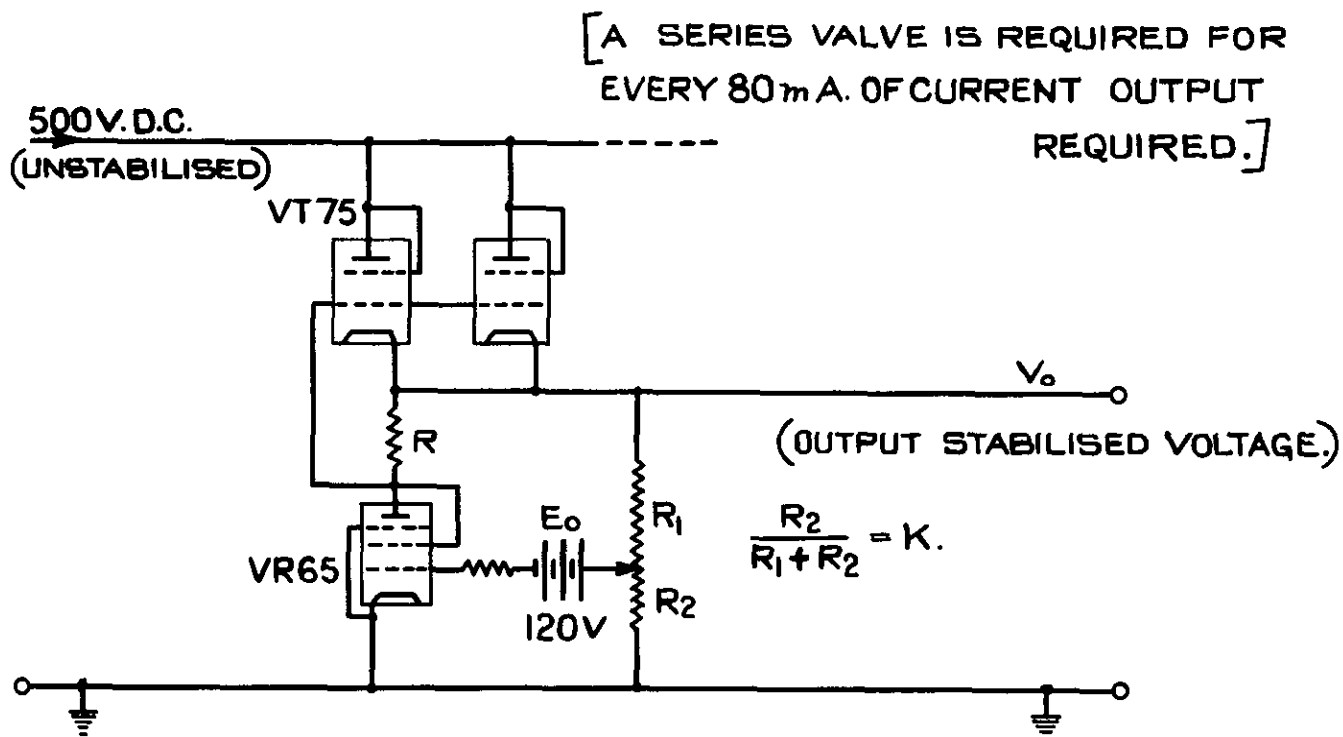

FIG.4 BASIC DIAGRAM OF SIMPLE STABILISING UNIT.



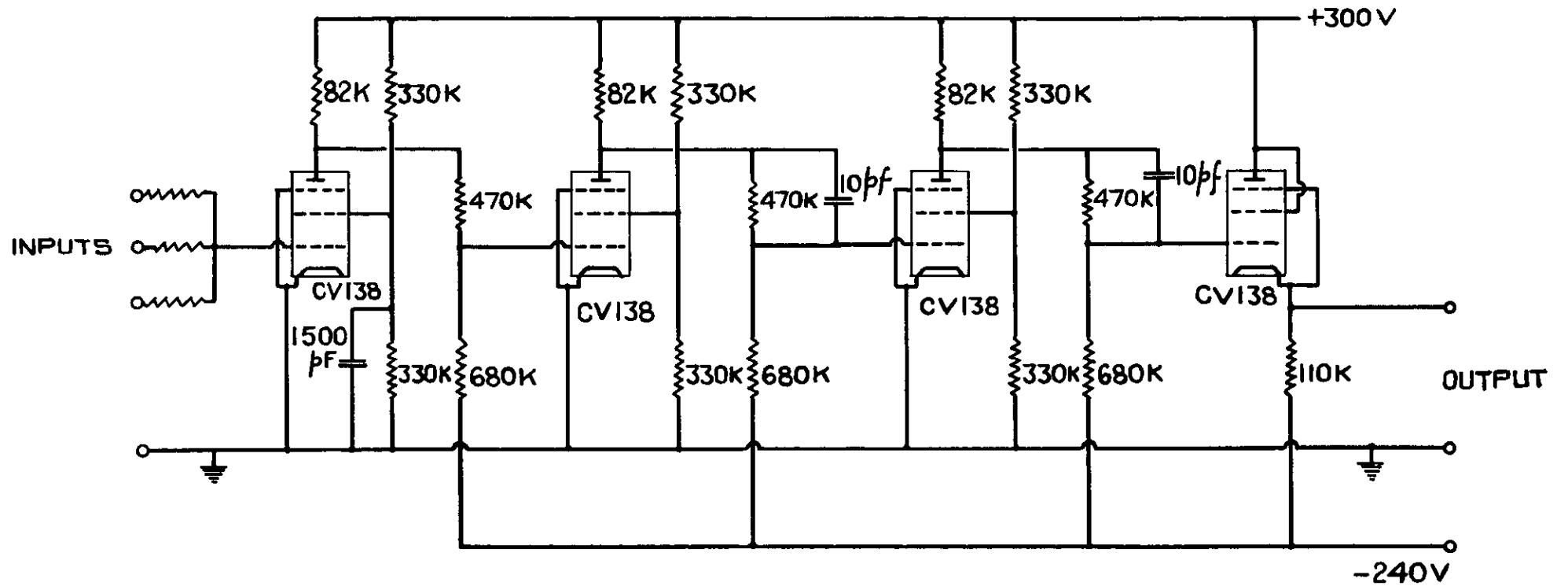

FIG.5 CIRCUIT DIAGRAM OF T.R.E. MINIATURISED D.C. AMPLIFIER.



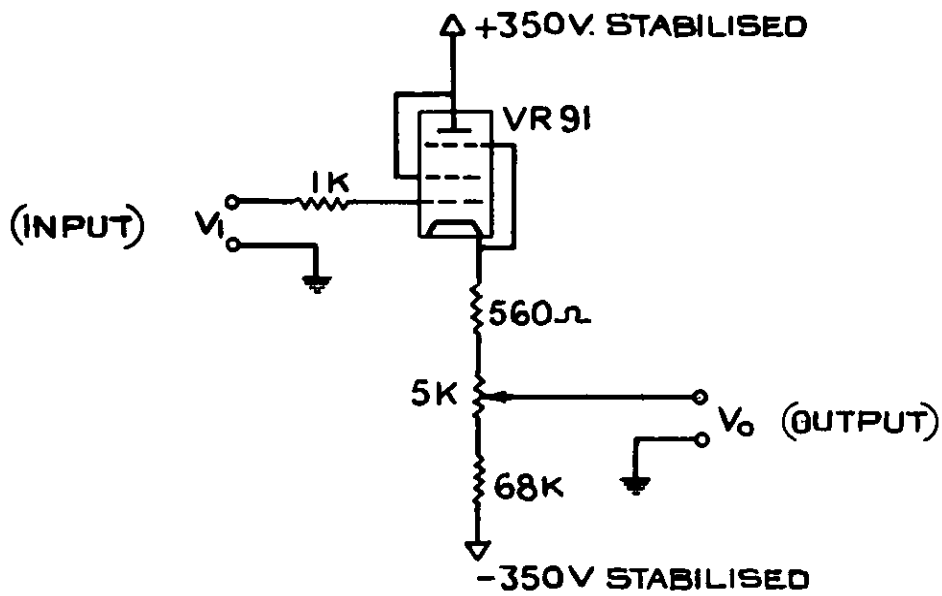

FIG.6 CATHODE FOLLOWER.

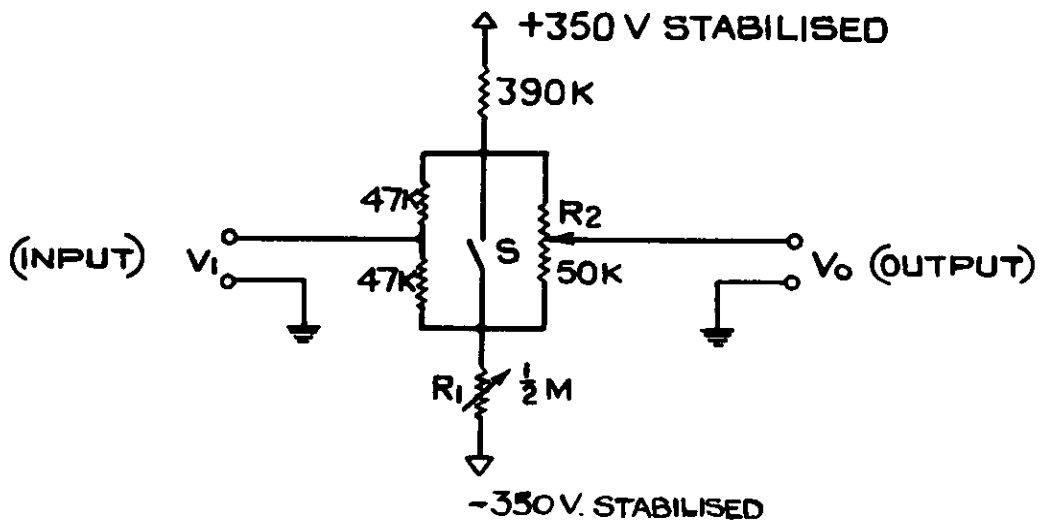

FIG.7 STEP CIRCUIT.

7

8

9

10

11

12



INTEGRATOR WITH TIME CONSTANT = RC SECS.



SUMMING AMPLIFIER.

SYMBOLS:-



REVERSING AMPLIFIER.



CATHODE FOLLOWERS.



STEP CIRCUIT.

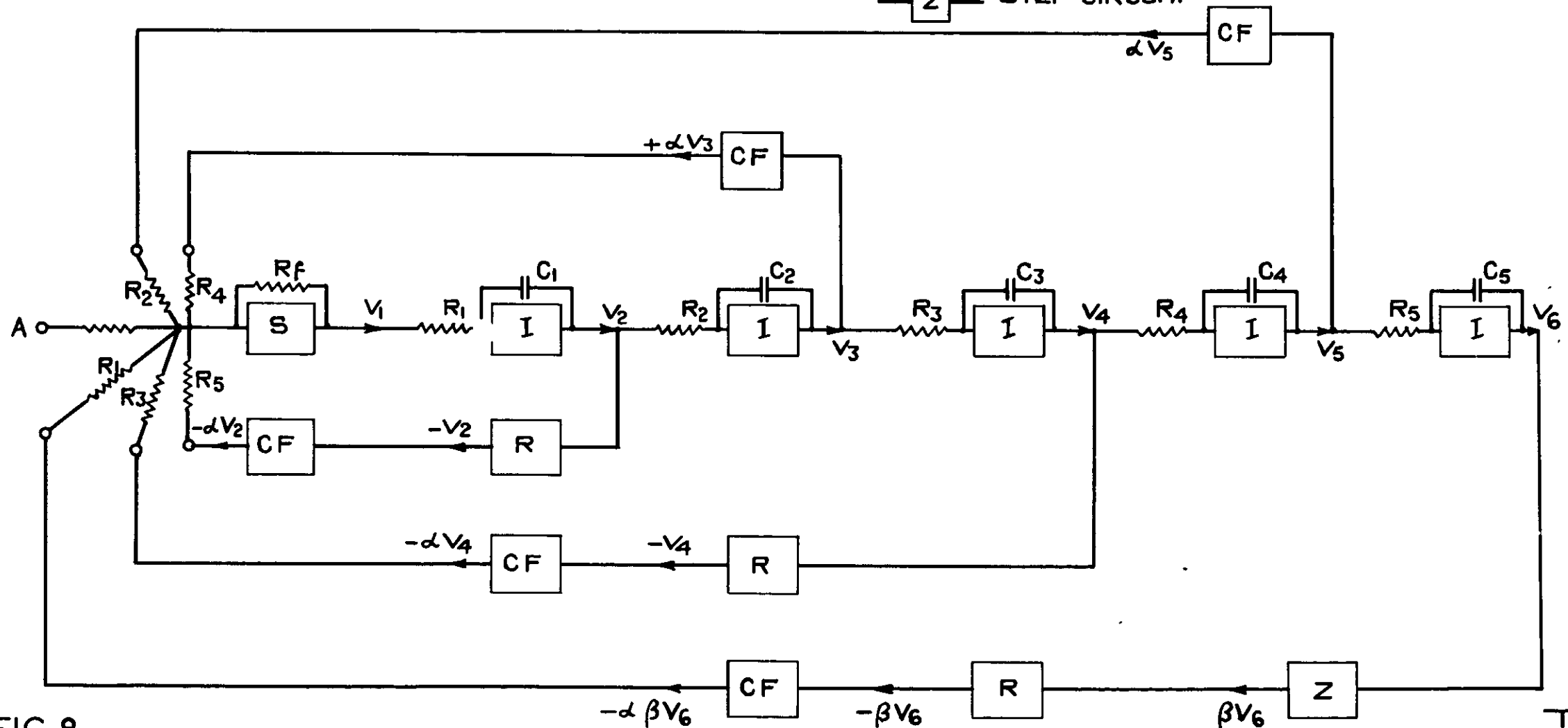

FIG. 8
 BLOCK DIAGRAM OF THE COMPLETE ANALYSER AS USED FOR SOLVING A FIFTH
 ORDER LINEAR DIFFERENTIAL EQUATION WITH CONSTANT COEFFICIENTS.

FIG: 8

.

12

13

14

15

16

17

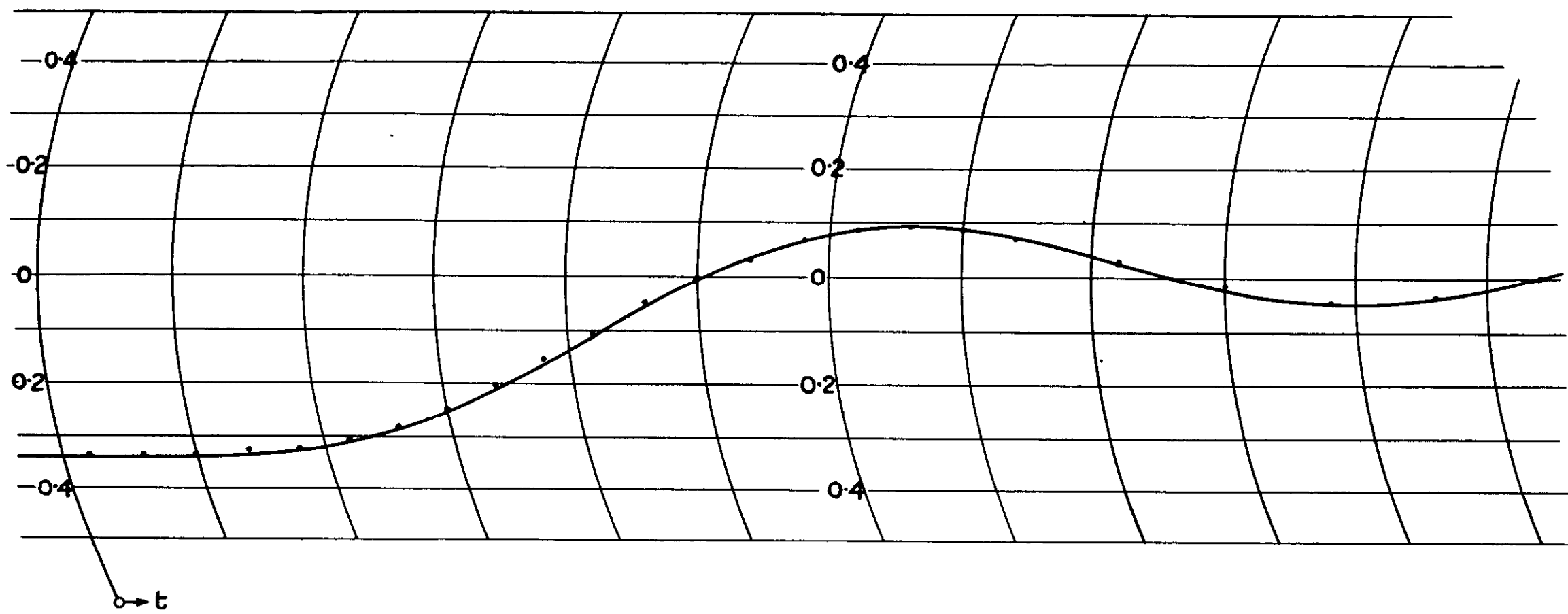

X { SCALE 1.35 DIVISIONS PER UNIT OF X
 TIME SCALE :- 1 DIVISION/SEC.

FIG.9 SOLUTION OF TEST PROBLEM.
 [THE DOTS REPRESENT THE CORRECT SOLUTION.]

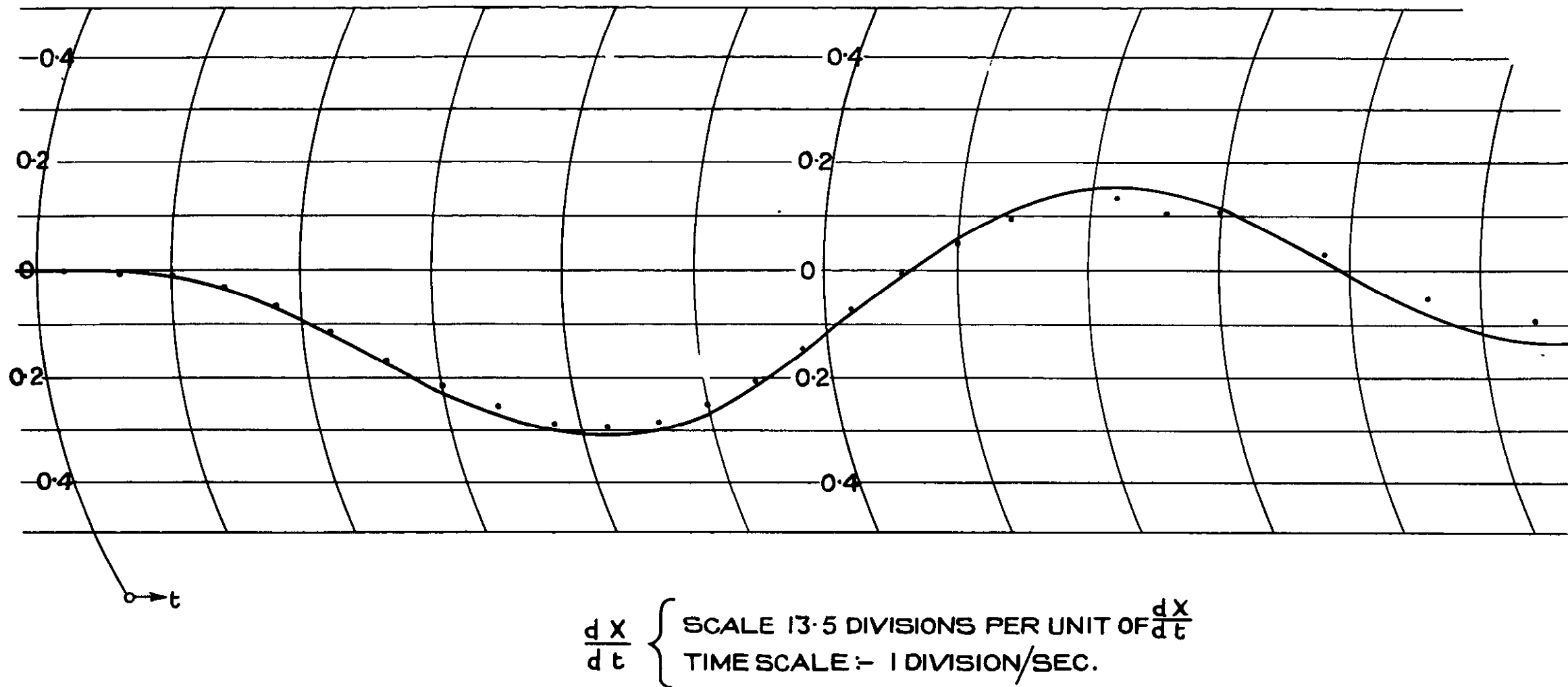
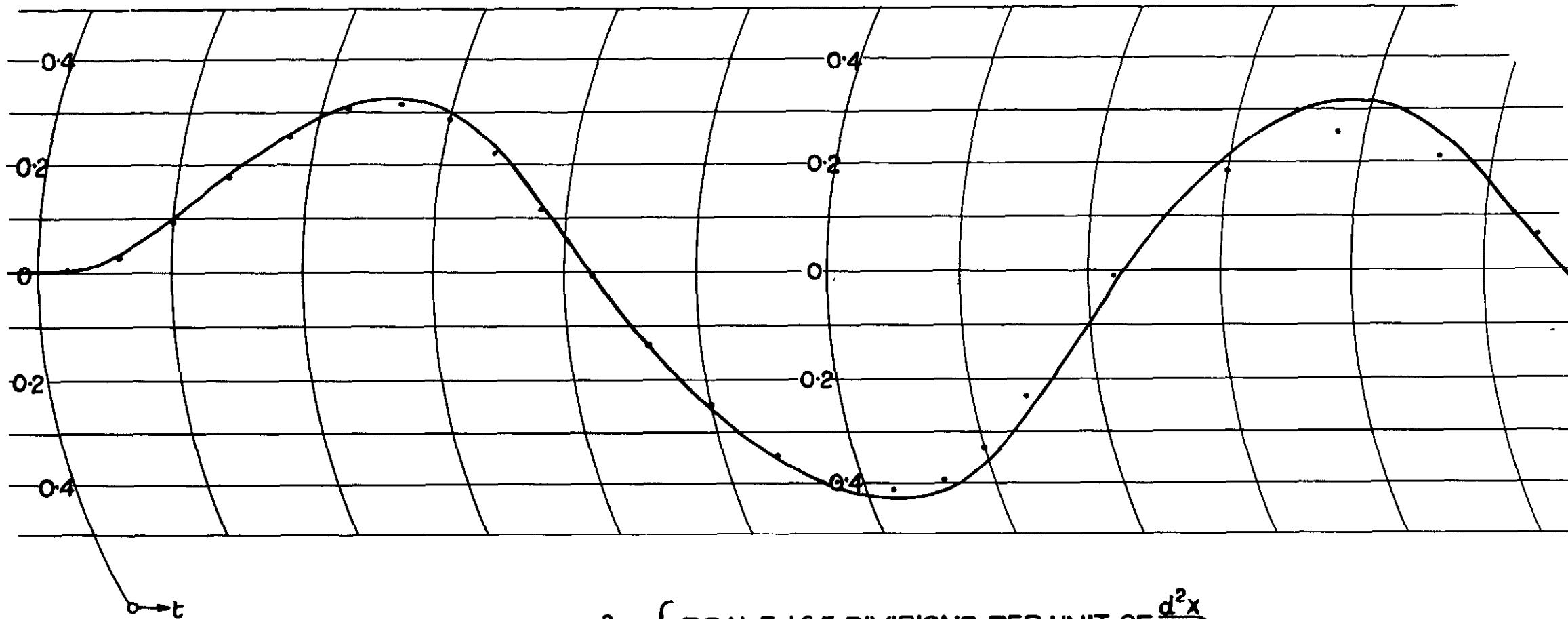

FIG.10 SOLUTION OF TEST PROBLEM.
 [THE DOTS REPRESENT THE CORRECT SOLUTION.]





$\frac{d^2x}{dt^2}$ { SCALE 165 DIVISIONS PER UNIT OF $\frac{d^2x}{dt^2}$
 TIME SCALE :- 1 DIVISION/SEC.

FIG. II SOLUTION OF TEST PROBLEM.
 [THE DOTS REPRESENT THE CORRECT SOLUTION.]

FIG: 11



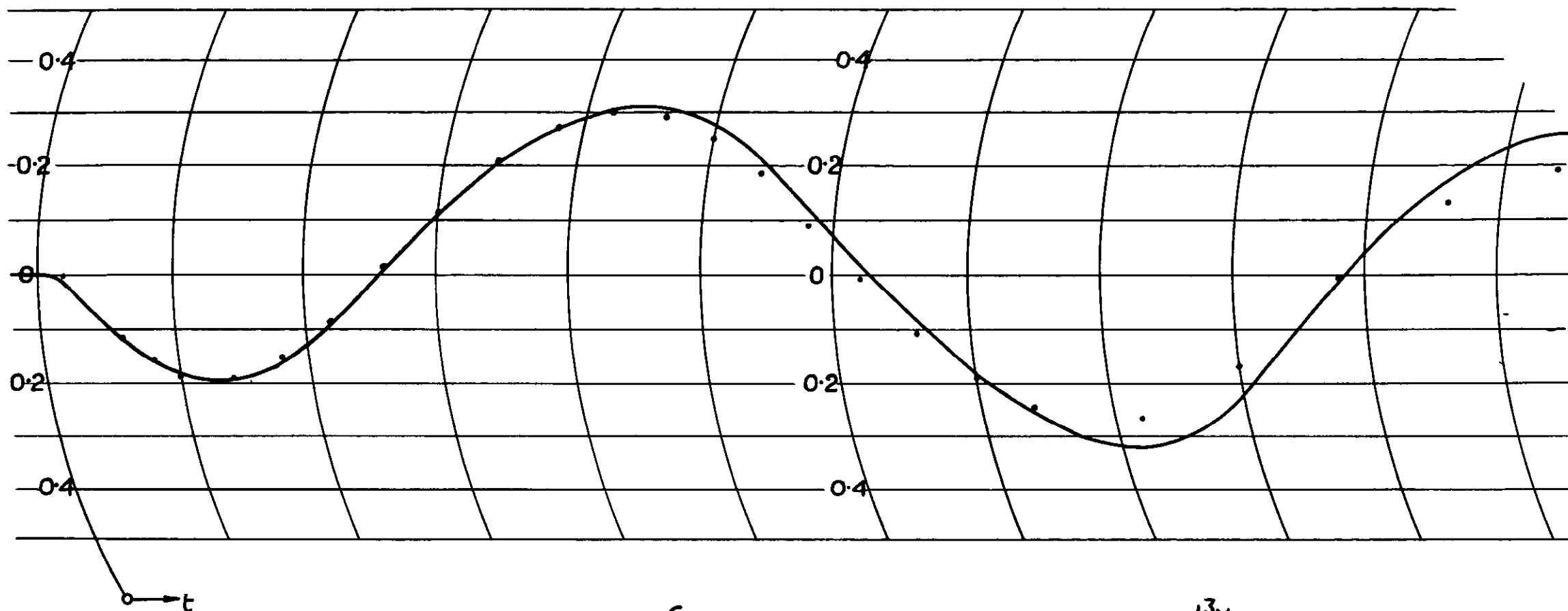

$\frac{d^3x}{dt^3}$ { SCALE 776 DIVISIONS PER UNIT OF $\frac{d^3x}{dt^3}$
 TIME SCALE: - 1 DIVISION/SEC

FIG.12 SOLUTION OF TEST PROBLEM.
 [THE DOTS REPRESENT THE CORRECT SOLUTION.]

FIG:12



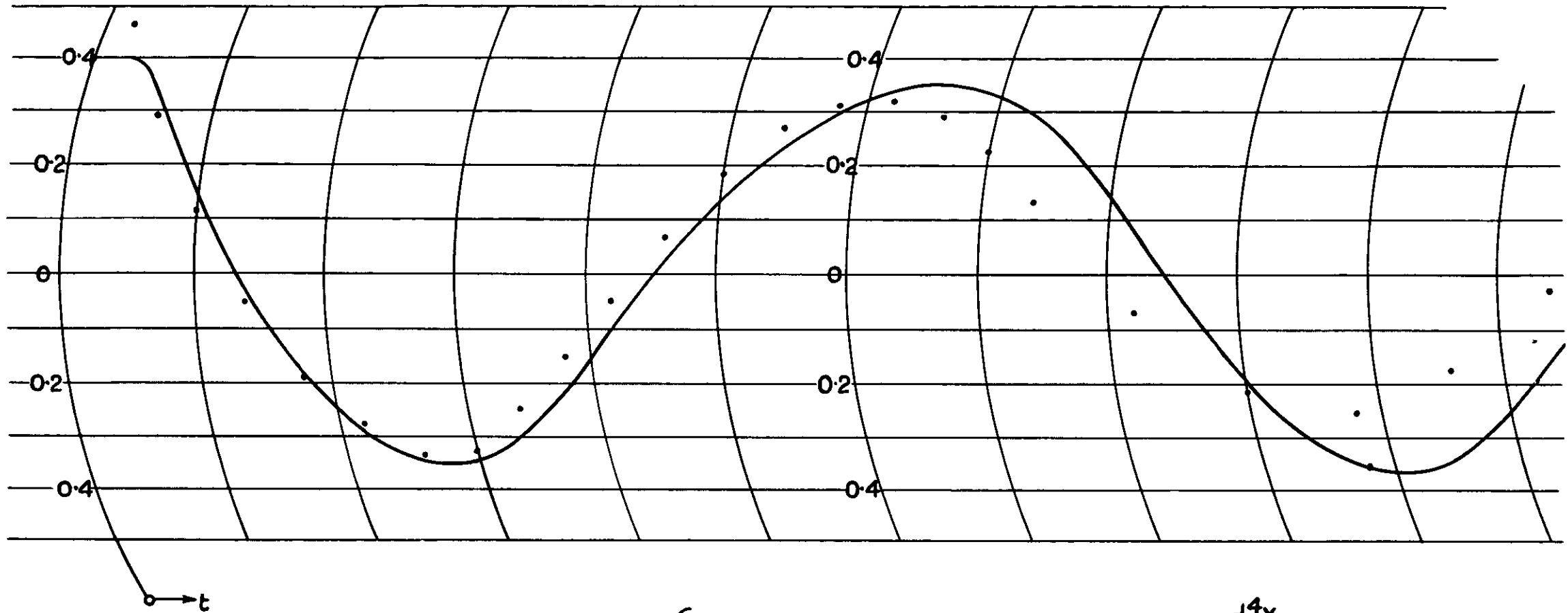

$\frac{d^4x}{dt^4}$ { SCALE 4949 DIVISIONS PER UNIT OF $\frac{d^4x}{dt^4}$
 TIME SCALE :- 1 DIVISION/SEC.

FIG:13.
 SOLUTION OF TEST PROBLEM.
 [THE DOTS REPRESENT THE CORRECT SOLUTION.]

FIG:13



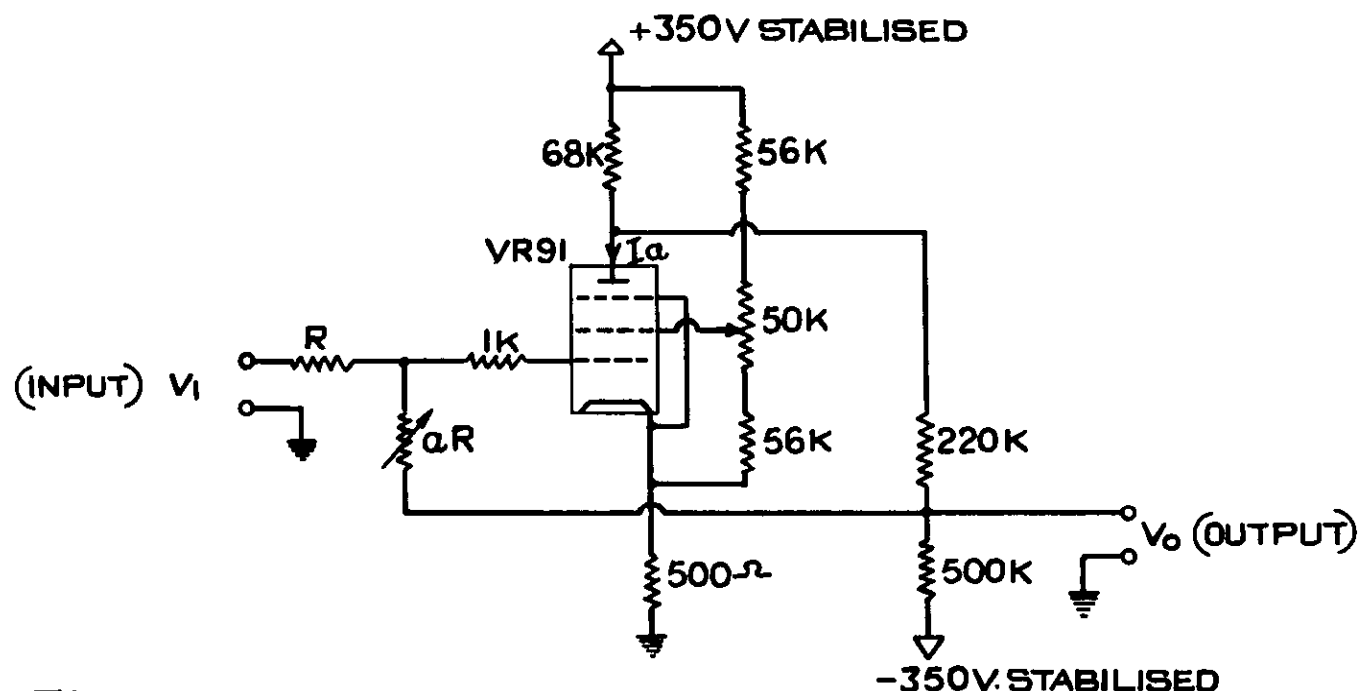

FIG.14
A SINGLE STAGE "SIGN-REVERSING"
FEEDBACK AMPLIFIER.

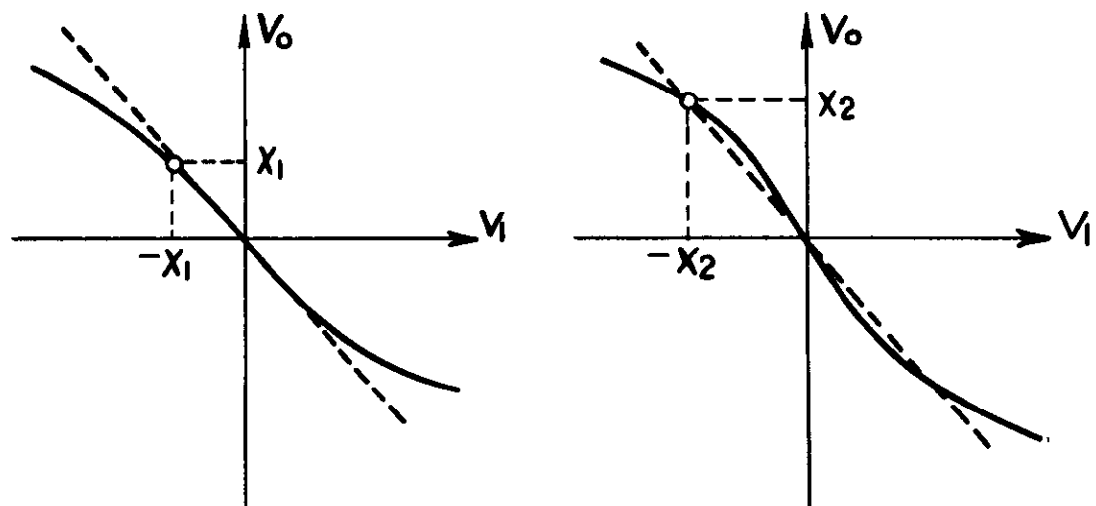

FIG.15
OVERALL CHARACTERISTICS OF "SIGN-REVERSING"
AMPLIFIER SHOWING DEPENDENCE ON THE
SETTING-UP VOLTAGE X.



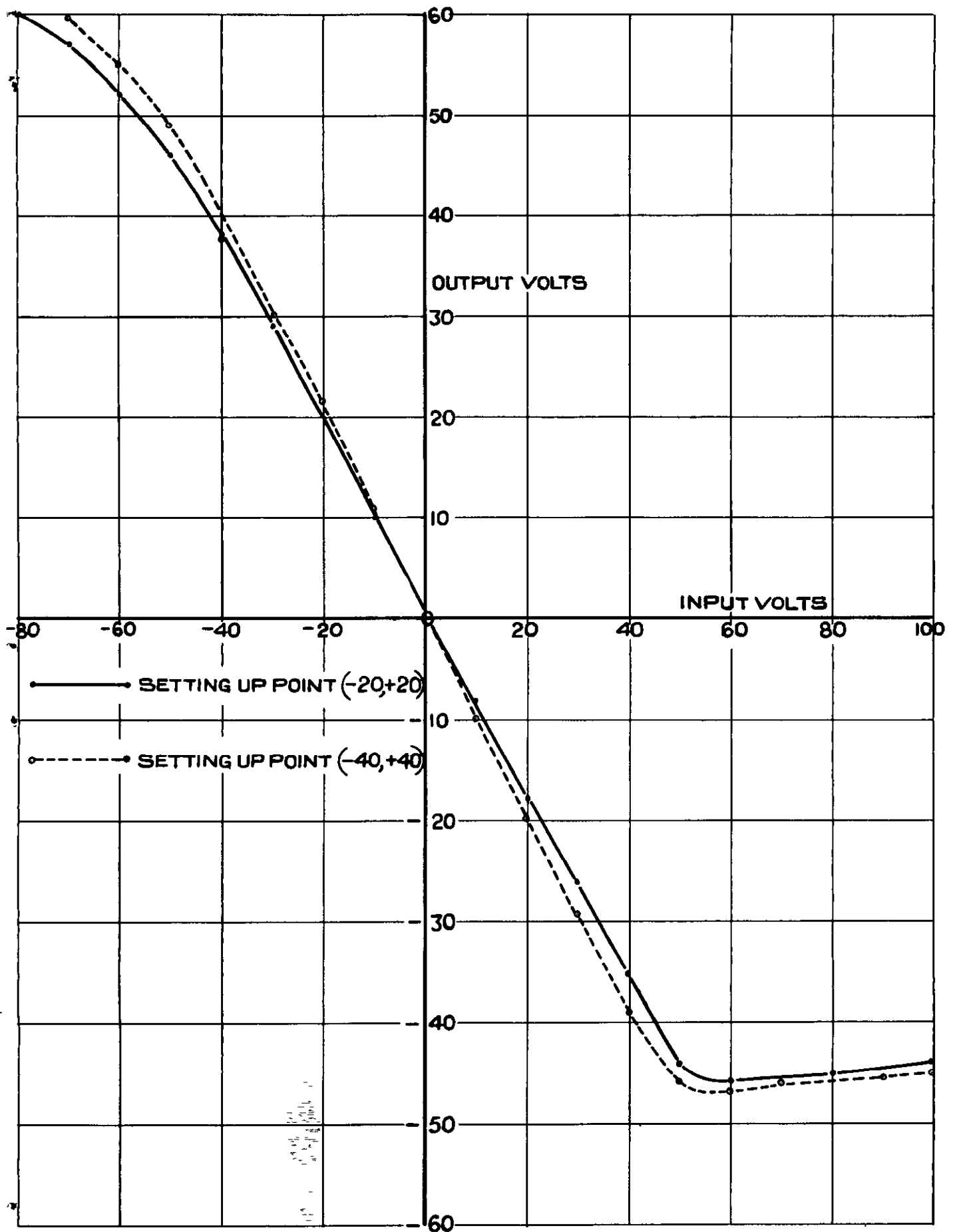
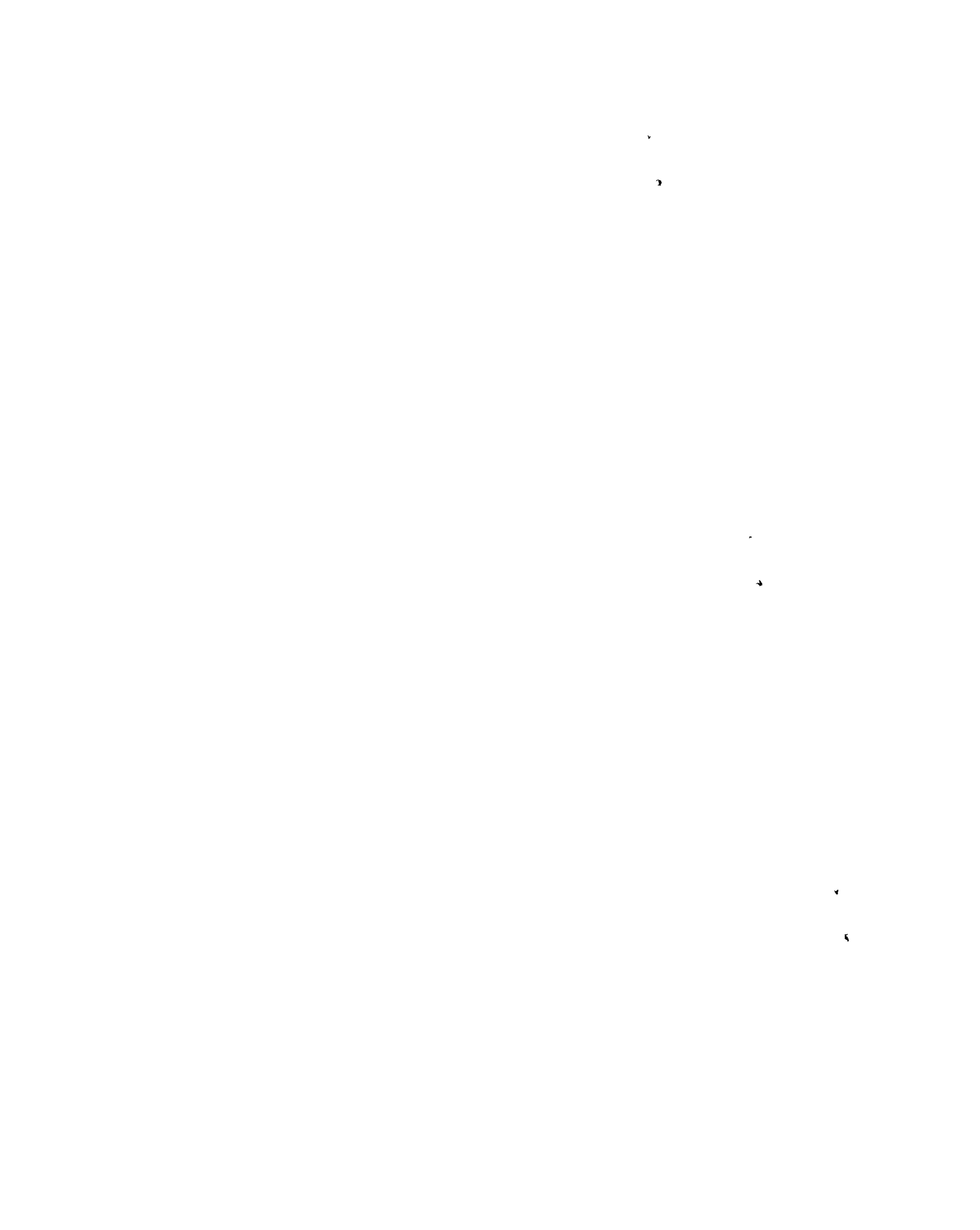

FIG:16.
EXPERIMENTAL CHARACTERISTICS OF
"SIGN REVERSING" AMPLIFIER.



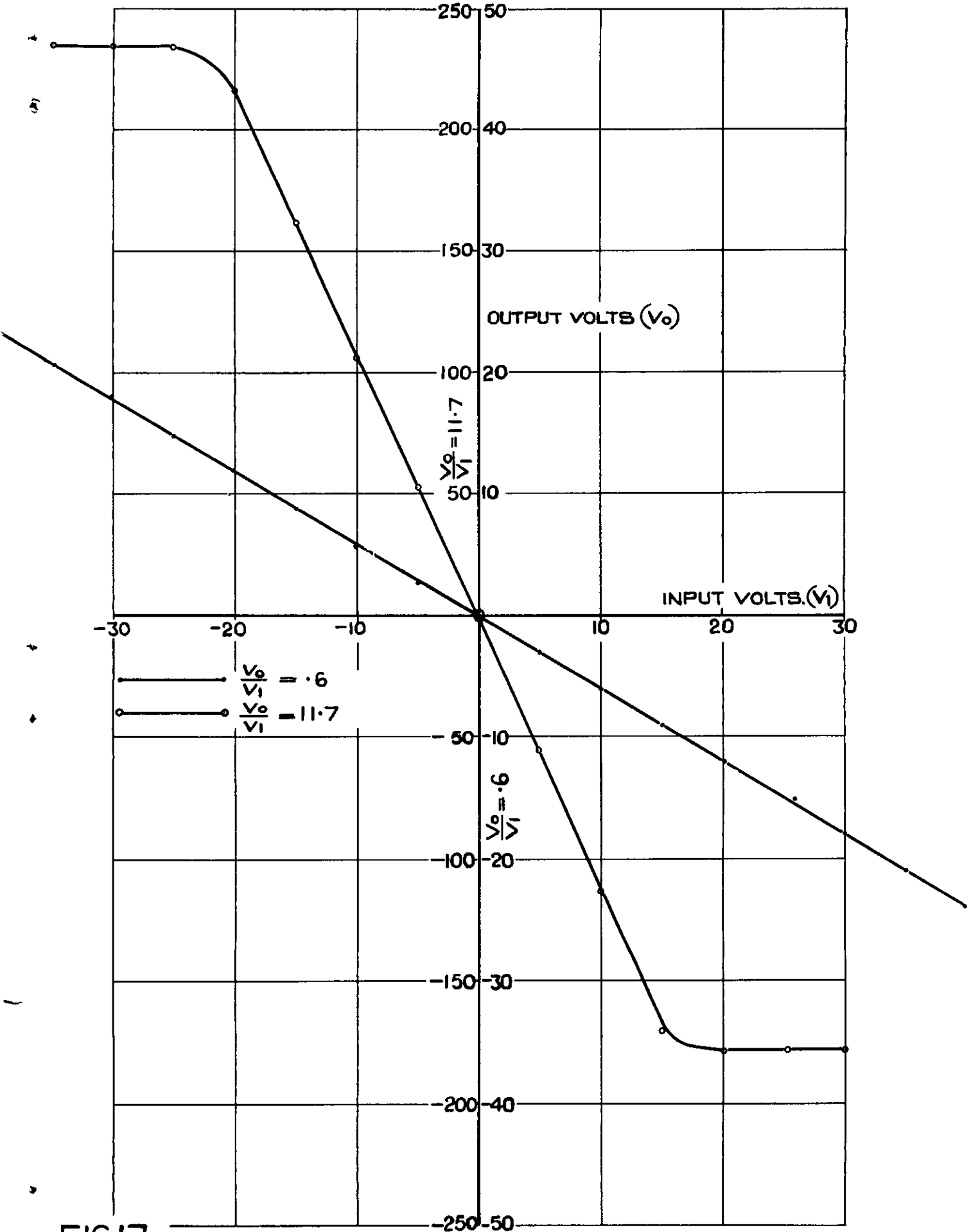
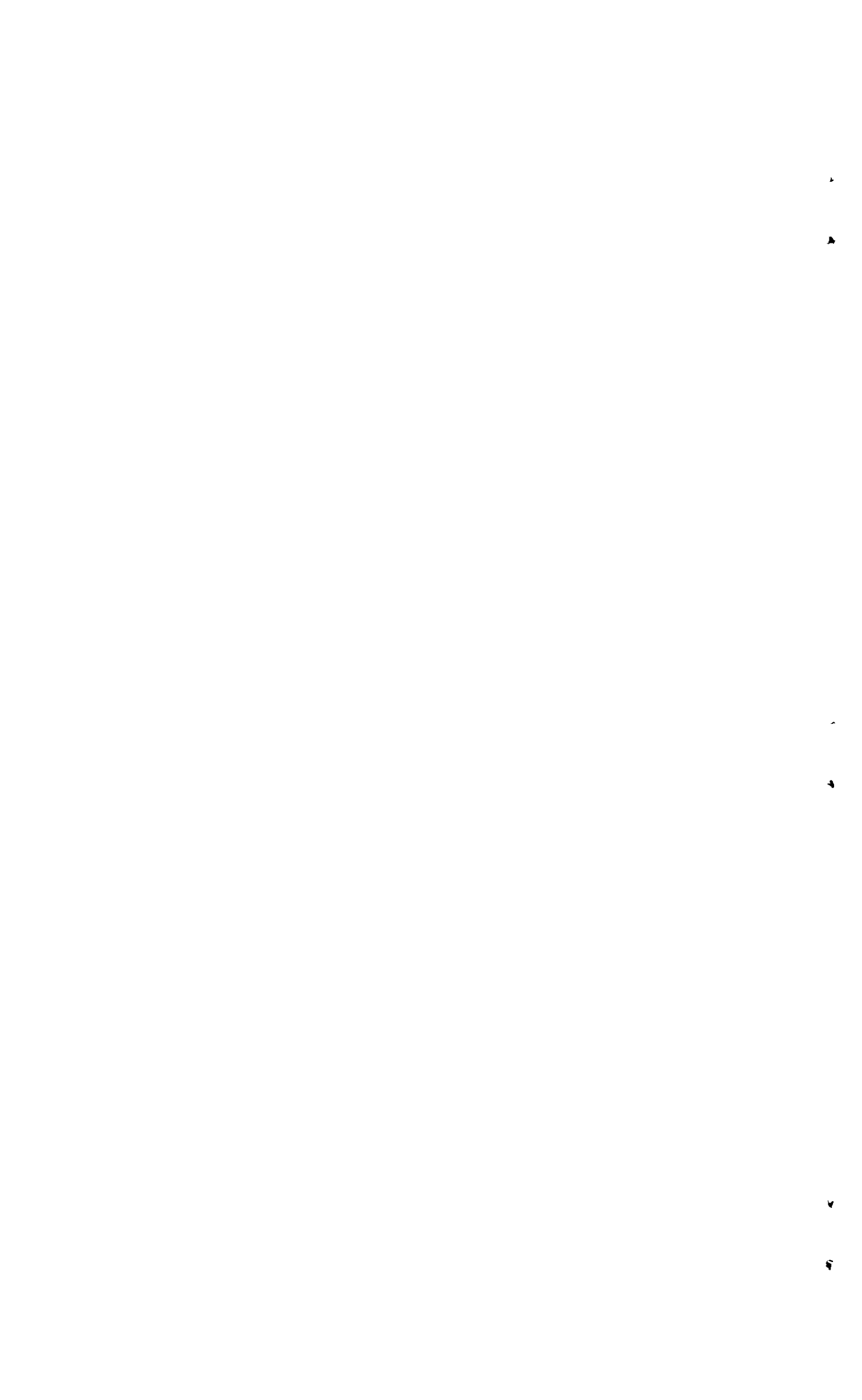

FIG.17

EXPERIMENTAL CHARACTERISTICS OF HIGH-GAIN SUMMING AMPLIFIER. (GAIN=30,000)



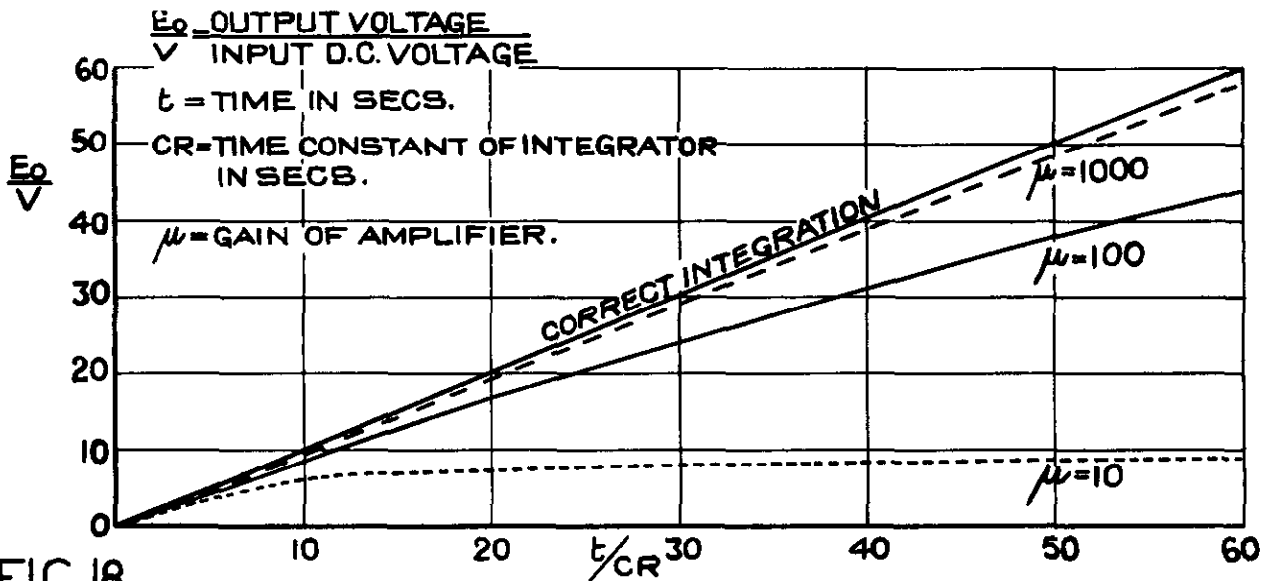

FIG.18 THEORETICAL CURVES SHOWING TYPE OF ERROR OBTAINED ON INTEGRATION OF A D.C. VOLTAGE.

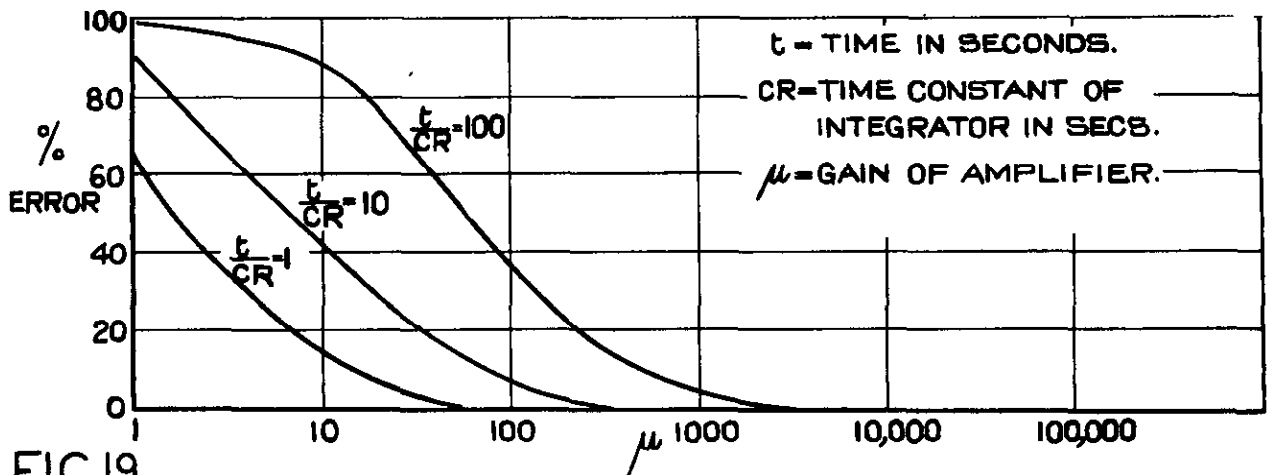

FIG.19 THEORETICAL CURVES SHOWING % ERROR ON INTEGRATION OF A D.C. VOLTAGE

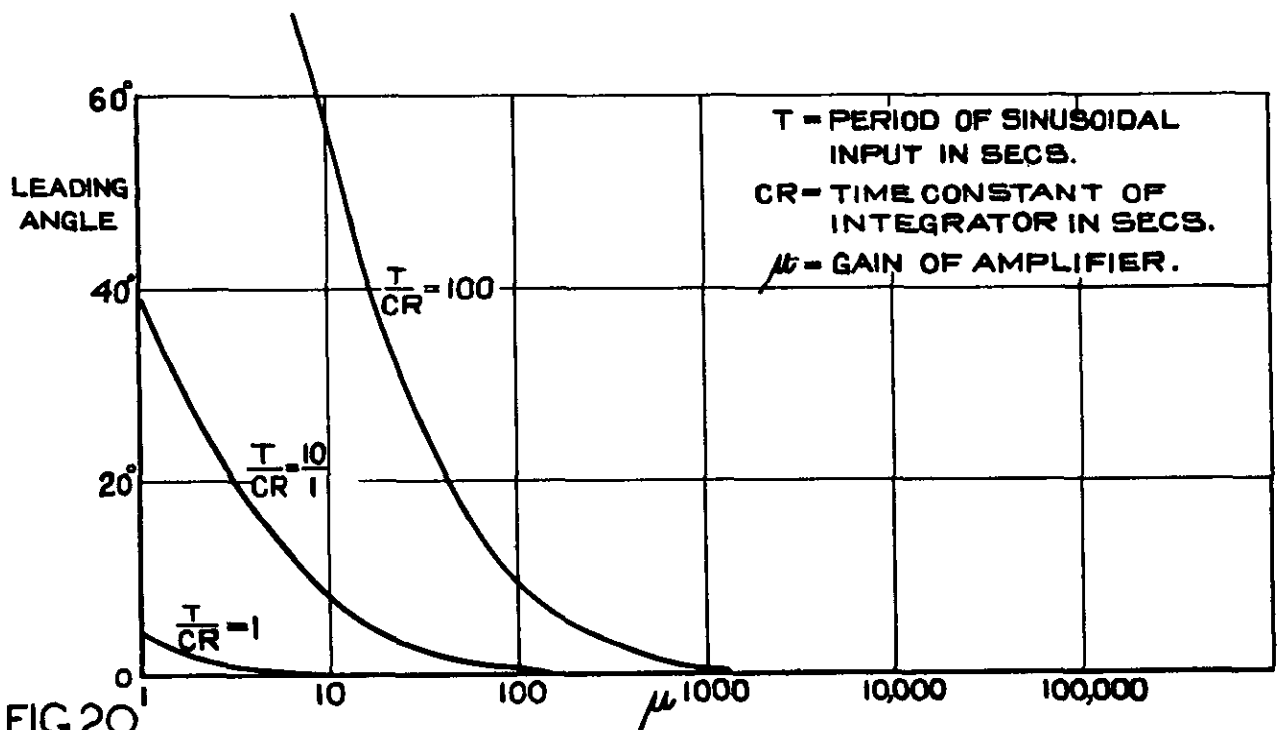
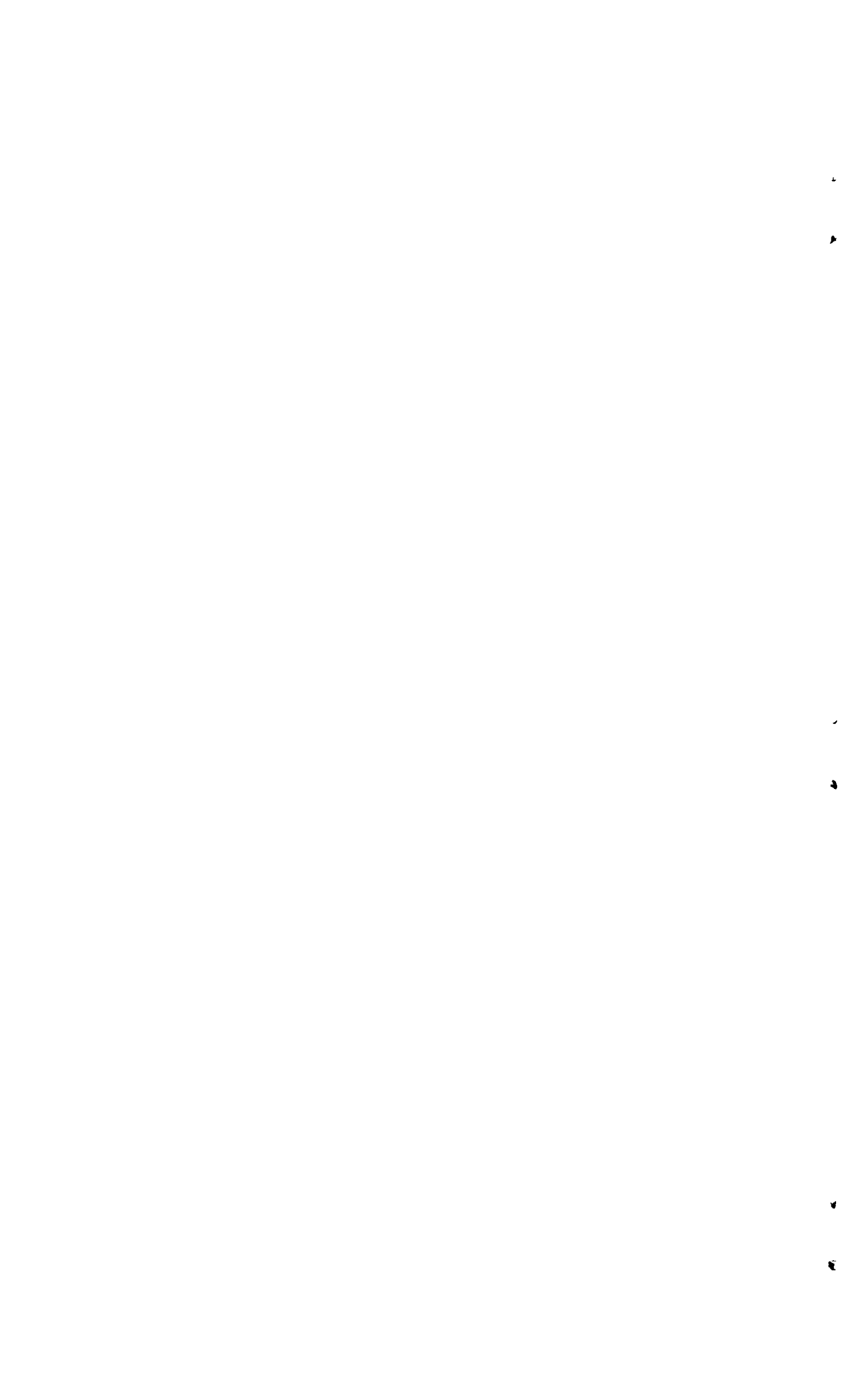

FIG.20 THEORETICAL CURVES SHOWING LEADING ANGLE ERROR ON INTEGRATION OF A SINUSOIDAL WAVE.



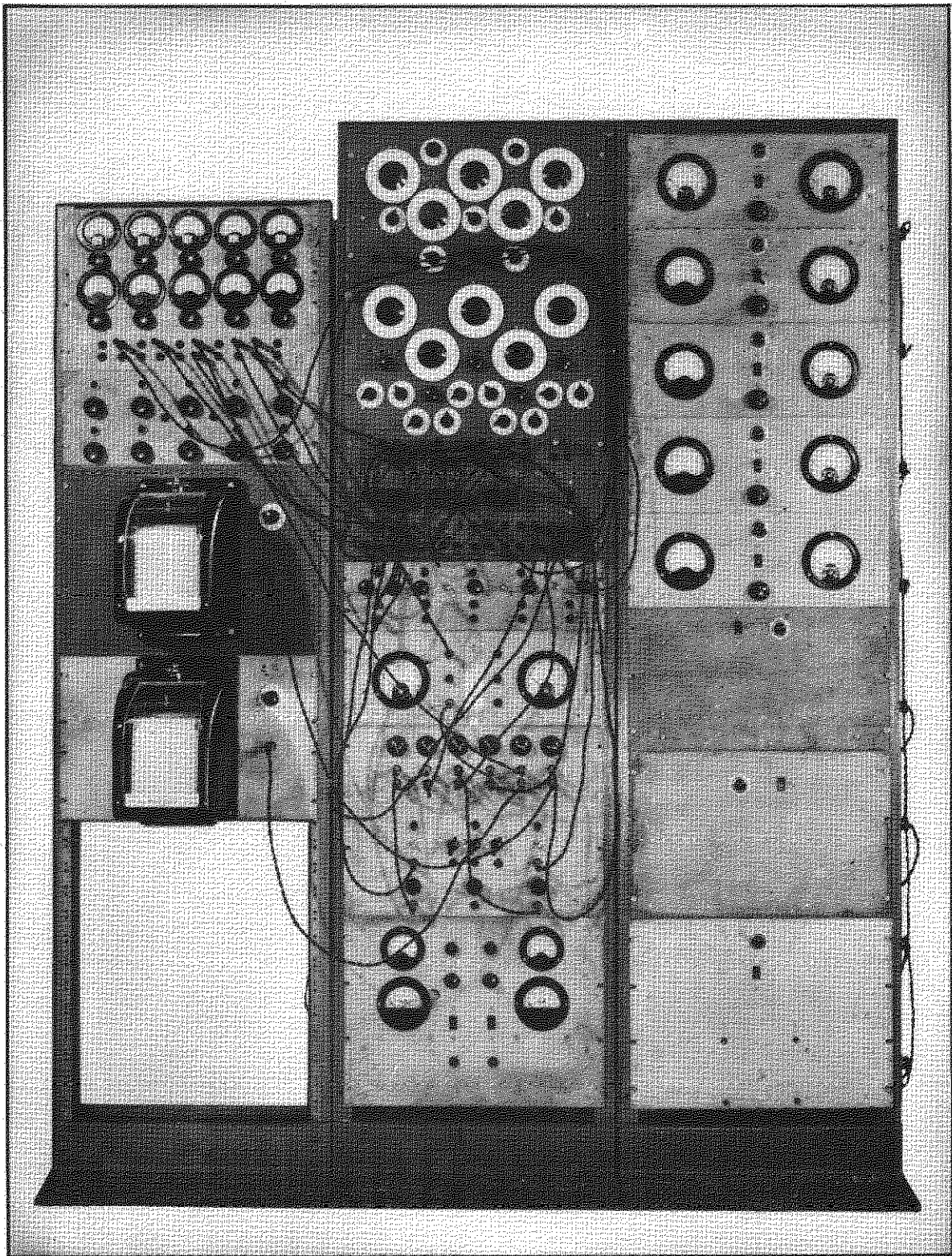
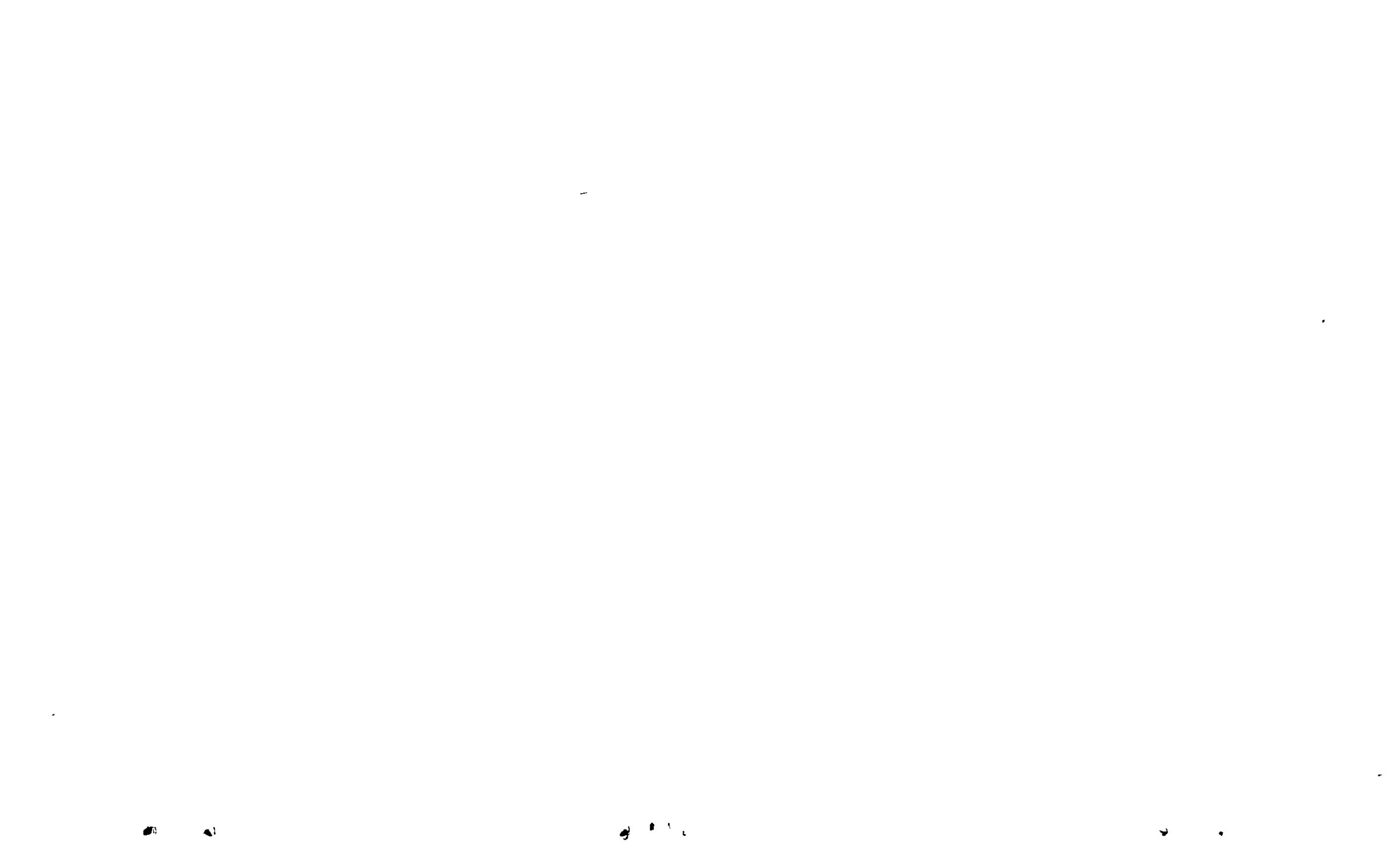

FIG.21.



PUBLISHED BY HIS MAJESTY'S STATIONERY OFFICE

To be purchased from

York House, Kingsway, LONDON, W C 2, 429 Oxford Street, LONDON, W 1,

P.O. BOX 569, LONDON, S E 1,

13a Castle Street, EDINBURGH, 2 | 1 St Andrew's Crescent, CARDIFF

39 King Street, MANCHESTER, 2 | 1 Tower Lane, BRISTOL, 1.

2 Edmund Street, BIRMINGHAM, 3. | 80 Chichester Street, BELFAST,

or from any Bookseller

1950

Price 3s. 0d. net