

MINISTRY OF SUPPLY  
AERONAUTICAL RESEARCH COUNCIL  
REPORTS AND MEMORANDA

Tests on a Whirlwind Aircraft in the  
Royal Aircraft Establishment  
24-ft Wind Tunnel  
(in two parts)

*By*

T. V. SOMERVILLE, B.Sc., R. R. DUDDY, B.Sc.,  
and G. H. L. BUXTON, B.A.

*Crown Copyright Reserved*

LONDON: HER MAJESTY'S STATIONERY OFFICE

1953

FIVE SHILLINGS NET

# Tests on a Whirlwind Aircraft in the Royal Aircraft Establishment 24-ft Wind Tunnel

(in two parts)

By

T. V. SOMERVILLE, B.Sc., R. R. DUDDY, B.Sc., and G. H. L. BUXTON, B.A.

COMMUNICATED BY THE PRINCIPAL DIRECTOR OF SCIENTIFIC RESEARCH (AIR),  
MINISTRY OF SUPPLY

*Reports and Memoranda No. 2603\**

June 1940

*Summary.*—Tests were made in the 24-ft Wind Tunnel during March and April, 1940, on the *Whirlwind* aircraft to find if simple modifications can be introduced which will decrease its drag. The drag analysis is not complete and is focused chiefly on the drag due to leaks, cooling and excrescences.

A complete record of the tests together with explanatory paragraphs is given in the tables of this note. The modifications which gave an appreciable saving in drag and which are considered possible to apply to the production aircraft are listed below.

Item	Saving in drag lb at 100 ft/sec
Sealing of leaks and gaps, Tables 1, 2 and 3	3·1
Fairing of exhaust cooling ducts, Table 4 ..	2·2
Fairing of main cooling inlet, Table 5 ..	2·4
Total .. .. .	7·7

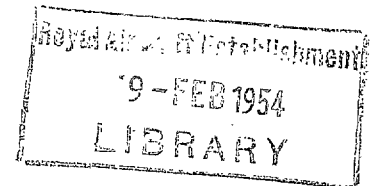

This saving in drag corresponds to an increase in maximum speed of about 15 m.p.h. A further saving in drag of 0·8 lb can be obtained by sealing the cartridge chutes (Table 6).

1. *Introduction.*—The general arrangement of the *Whirlwind* aircraft is shown in Fig. 1 and further particulars are given in Table 8.

For the purpose of the tests in the 24-ft Wind Tunnel a pylon and tail strut replaced the existing undercarriage and tail-wheel. The compartments into which these retract are closed by doors, and the under surfaces of the nacelles and of the tail unit were fitted with similar doors to represent the retracted condition. During the tests all leaks in the outer wing, which was outside the jet, were sealed.

The aircraft is fitted with Peregrine engines and the airscrews were replaced by spinners during the tests. Four dummy shell guns were fitted in the nose for the gun tests.

The thrust line incidence was set at 2·3 deg at a  $C_L$  based on the wing area inside the tunnel jet of 0·15. The drags quoted are mean values derived from the three test speeds of 80, 100 and 120 ft/sec.

\* R.A.E. B.A. Dept. Note L.W.T. No. 30. R.A.E. B.A. Dept. Note L.W.T. No. 34.

2. *Results.*—2.1. *Leak Drags.*—The effect of leaks on drag was found by sealing the aeroplane completely and unsealing in stages. A more detailed analysis of some of the larger leak drag items was then made.

The following tables give a detailed account of the drag differences due to successive modifications.

TABLE 1

Item		Drag increase lb at 100 ft/sec
1	Datum. Aircraft completely sealed; Radiator cooling ducts open	
2	Leak between exhausts and nacelle cowling unsealed; both nacelles .. .. .	0.4
3	Tail unit unsealed (rudder and elevator gaps and miscellaneous leaks)	2.8
4	Fowler flap unsealed .. .. .	0.8
5	Cooling flaps seams unsealed .. .. .	0.5
6	Coupé seams and gaps unsealed .. .. .	0.3
7	Aircraft completely unsealed—all remaining seams unsealed including nacelle panels and spinner gaps .. .. .	0.7
8	Inserting a diaphragm to seal the tail unit from the fuselage ..	0.3
	Total decrease in drag by sealing leaks (items 2 to 7) .. ..	5.5

TABLE 2

*Sealing of Fowler flap. Analysis of Item 4 Datum—Condition 8*

Item		Drag decrease lb at 100 ft/sec
9	Leaks from the radiator duct sideways into space between Fowler flap and wing sealed.	
	Gap between leading edge Fowler flap and wing sealed .. ..	0.5
10	Gap between fuselage and trailing edge Fowler flap sealed .. ..	0.2
11	Seams at junction of Fowler flap and sides of nacelle sealed .. ..	−0.7
12	Leak at trailing edge of Fowler flap outboard of nacelle sealed ..	0.8
	Net gain by completely sealing Fowler flap .. .. .	0.8

TABLE 3

*Sealing of Tail Unit. Analysis of Item 3**Datum—Tail Diaphragm inserted. Fowler flap sealed (condition 12)*

Item		Drag decrease lb at 100 ft/sec
13	Miscellaneous leaks sealed .. .. .	0.6
14	Gap between rudder horn and fin sealed and faired .. .. .	1.2
14a	By sealing the rudder horn nose gap only, 0.6 lb was saved ..	
15	Elevator and rudder control gaps sealed .. .. .	1.0
	Net gain by complete seal of tail unit .. .. .	2.8

The value of sealing an individual leak depends on the other leaks which are present and any other sequence of unsealing might give different values although the overall result of a complete unseal would be the same.

The modifications which are considered possible to make on the production aircraft are items 2, 5, 6, 9, 10, 13, 14a, which give a drag decrease of 3.1 lb.

*2.2. Exhaust Cooling System*

TABLE 4

*Datum—Completely sealed. (Condition 1)*

Item		Drag decrease lb at 100 ft/sec
16	Removal of plug fairings at entry to exhaust cooling ducts allowing normal cooling air to pass through duct .. .. .	-2.3
17	Fairing of exhaust cooling ducts (this sealed the leak between the exhausts and the nacelle cowling) .. .. .	2.6
	From item 3, sealing leaks between exhausts and nacelle cowling ..	0.4
18	Hence gain by fairing without sealing .. .. .	2.2

The 2.3 lb increase in drag by unsealing the exhaust cooling ducts is largely external spoiling drag at the entry, as the flow is small and internal drag must be low. The decrease of 2.2 lb in external drag of the ducts was obtained by building a large Plasticine fairing on to the cowling so that it had a smooth continuous line from the duct entry back to the exhaust pipe as indicated in Fig. 2. The lip was shaped in an easy curve to accommodate the fairly abrupt outward sweep of the air which passes over the duct as well as the sudden internal expansion to fill the duct itself. It is proposed that the air to cool that part of the exhaust pipe covered by the fairing should be led from the inside of the duct to eject backwards at the rear of the pipe.

2.3. *Cooling-Drag Measurements.*—The cooling air for each engine enters through a slit in the leading edge of the inner wing extending from the nacelle to the fuselage and is led by a duct to an exit near the trailing edge between a controllable flap on the upper surface of the wing and the Fowler flap as shown in Figs. 3, 4. The duct encloses three 10-in. diameter radiators ( $5 \times 300$  mm hexagonal tubes) and one  $6\frac{1}{4}$ -in. diameter oil-cooler. These tests were made with the radiator duct sealed from the rest of the aeroplane except for flow measurements made in climbing attitude with the Fowler flap down.

To obtain a datum for the cooling drag the ducts were closed by a nose fairing shaped to the leading edge of the wing and by a trailing edge fairing at exit.

It was suspected that the large external drag (1.9 lb under top speed conditions. See Fig. 6) was due to disturbed flow over the upper and lower surfaces of the wing at the junctions of the duct with the fuselage and nacelle and examination of wool tufts confirmed this. The entry was modified by making semi-circular ends to the ducts with a fillet tapered forward on to the nacelle or fuselage. The end of the duct was first built up to the original leading edge of the wing with Plasticine, the fillet put on and the semi-circular ends cut out and corners rounded off. Sketches of the two best types of fairing tested are shown in Fig. 5.

Assuming that the internal drag was unchanged by these modifications, the reduction in external drag for both ducts due to the best fairing was 2.4 lb at 100 ft/sec, of which 1.2 lb was due to the fuselage ends and 1.2 lb to the nacelle ends.

The effect of these fairings was solely connected with the cooling since there was no appreciable reduction in drag when similar fillets were put on when the wing was faired and the cooling flow stopped.

The main results are summarised in Table 5.

TABLE 5

*Drag Analysis lb at 100 ft/sec Corresponding to the Top-speed Position of the Cooling Flap at a flow of 50 cu ft/sec at 100 ft/sec,  $v/V = 0.28$  at radiator*

The figures given are for one engine only.

	Original duct entry	Modified duct entry
Minimum internal drag	2.9 .. .. .	2.9
Residual internal drag ..	0.2 .. .. .	0.2
External drag .. ..	1.9 .. .. .	0.7
Cooling drag .. ..	5.0 = 9.2 per cent b.h.p. at 360 m.p.h. at 16,000 ft	3.8 = 7.0 per cent b.h.p. at 360 m.p.h. at 16,000 ft
Nacelle drag* .. ..	6.3 .. .. .	6.3
	11.3 = 20.8 per cent b.h.p.	10.1 = 18.6 per cent b.h.p.

\* Estimated from R.A.E. report B.A. 1460.

Cooling drags and variation of flow with exit area keeping the Fowler flap neutral are given in Figs. 6, 7.

The maximum cooling flow which can be drawn through one duct with the aeroplane in climbing attitude (Fowler flap down 12 deg and cooling flap at maximum opening) is 71 cu ft/sec at 100 ft/sec giving a ratio of maximum flow to top-speed flow of 1.5.

## 2.4. Drag of Guns

TABLE 6

*Datum—Aircraft as received with Dummy Guns Fitted. Cartridge chutes open*

Item		Drag decrease lb at 100 ft/sec
19	Sealing cartridge chutes only .. .. .	0.8
20	Removal of guns .. .. .	0.4

## 2.5. Drag of Cabin top (coupé)

TABLE 7

*Datum—Coupé on and unsealed*

Item		Drag decrease lb at 100 ft/sec
21	Sealing of coupé .. .. .	0.3
22	Coupé removed. Faired panel put on and sealed .. .. .	0.9

The increase in drag due to the shape of the cabin is thus 0.9 lb which is approximately 3.0 times the flat-plate skin-friction drag of the extra surface area added.

*Conclusions.*—The total drag which can be saved by sealing leaks and covering gaps is about 3.5 lb at 100 ft/sec. This is quite small compared with values found on previous aircraft and nacelles. The tunnel tests show that it is possible to reduce this drag by about 3.1 lb.

The further reductions in drag shown possible are connected with the cooling systems for the exhausts and radiators. The actual reduction obtained by adding Plasticine fairings was 4.6 lb at 100 ft/sec. This is not necessarily the maximum amount which can be gained as the time allowed did not permit a complete investigation.

These items total 7.7 lb which corresponds to an increase in the top speed of the aircraft of approximately 15 m.p.h. A further saving of 0.8 lb can be obtained by sealing the cartridge chutes.

TABLE 8

### *General Particulars*

#### 1. Dimensions of aeroplane

Length .. .. .	32.25 ft	
Span .. .. .	45.0 ft	
Including part spanned by fuselage	Wing area .. .. .	250 sq ft
	Wing area in tunnel jet .. .. .	158 sq ft
	Total surface area .. .. .	1,067 sq ft
	All-up weight .. .. .	9,845 lb

#### 2. Power plant

Engines. 2 Peregrine, 885 h.p. at 15,000 ft at 3,000 r.p.m.

#### 3. Radiator

Water (70 per cent) and glycol (30 per cent) : 3 circular matrices 5 × 300 mm hexagonal tubes. Total matrix frontal area : 1.58 sq ft.

Oil : 1 circular matrix 5 × 300 mm matrix frontal area : 0.21 sq ft.

#### 4. Radiator duct

Entry area .. .. .	1.29 sq ft
Total matrix area .. .. .	1.79 sq ft
Exit area, flap top-speed position .. .. .	0.74 sq ft

# Momentum Investigations on Fuselage-wing Interference and Nacelle Drag

*Summary.*—These tests extend the investigations described in the forepart<sup>1</sup> of this R. & M. and include the results of pitot-traverse measurements made to determine fuselage-wing interference and nacelle drag.

The conclusions are—

(1) The wing-fuselage interference effect on profile drag is about 2.0 lb at 100 ft/sec and the wing-nacelle interference is about 1.0 lb/nacelle.

(2) The external cooling drag appears to be concentrated at the two sides of the ducts, about 0.5 lb per duct being at the fuselage side and 1.2 lb at the nacelle side. It follows from the drag tests reported previously that the modified entry would eliminate the external drag at the fuselage side and leave about 0.6 lb at the nacelle side. Therefore it appears possible to improve this side.

(3) The drag of each nacelle is about 10.9 lb and 4.0 lb of this is due to the exhaust system. The modified exhaust cooling duct described in the first part of this report reduces the exhaust drag to 2.7 lb which is still rather high and suggests a possibility of further improvement.

1. *Introduction.*—Drag tests on the *Whirlwind* in the 24-ft Wind Tunnel have been described<sup>1</sup> previously. The present tests which took place during March and April, 1940, consist of pressure-head surveys in planes behind the wing in the vicinity of the fuselage and nacelle. By integrating the drag intensity calculated from these readings, an estimate has been made of the wing-fuselage interference and the drag of the nacelles.

2. *Description of Tests.*—Fig. 1 gives the general arrangement of this aeroplane and shows the location of the pitot traverses. The traverse of 0.28c behind the trailing edge of the wing was made both with the radiator duct open to give the cooling flow for the top-speed condition and also with the duct closed. This was done by blocking the entrance and building it up to form an aerofoil nose-shape and by blocking the exit with a fairing which continued in a smooth manner the contours of the wing to a new trailing edge about 6 in. behind the actual wing.

A second traverse of 0.12c behind the wing was made round the nacelle and adjacent wing, with the cooling duct open. The time allowed did not permit a similar investigation with the cooling flow stopped and this lack of data has prevented a rigorous drag analysis of this region.

These tests were made at an incidence of 2.3 deg and the cooling duct when open was sealed from the remainder of the aircraft. The Fowler flap leaks were also sealed but otherwise the aircraft was in the condition as received.

3. *Results.*—The drag intensity  $C_D'$  is calculated from the readings by the formula used by Jones<sup>2</sup> for two-dimensional exploration,

$$C_D' = 2 \sqrt{g - p}(1 - \sqrt{g - p_0})$$

where

$g$  = local total head,

$p$  = local static pressure,

$p_0$  = static pressure at the plane of measurement in the empty tunnel,

each expressed in terms of the tunnel dynamic head.

A typical drag intensity distribution across the wake behind the wing is shown in Fig. 8 and the contours of drag intensity obtained from such distributions are given in Figs. 9, 10, 11. The drag/foot run is obtained by integrating sections normal to the surface considered. The values around the fuselage and along the wing in the vicinity of the fuselage are shown in Figs. 12, 13. These figures include the estimated\* turbulent flat-plate skin-friction drag over the fuselage and the profile drag of the wing based on Young and Squire's calculations<sup>3</sup> for a transition point at 0.08c.

---

\* The turbulent flat plate skin friction drag/foot run round the fuselage is taken at  $\frac{1}{2}\rho V^2 \cdot l \cdot C_f'$  where  $l$  = distance from nose,  $V$  = tunnel speed, and  $C_f' = 0.455 \log_{10} \left( \frac{Vl}{\nu} \right)^{-2.58}$ .

4. *Discussion of Results.*—4.1. *Fuselage—Wing-Root Interference.*—The fuselage-wing interference has been estimated by the following method :—

- (a) The total drag over an area sufficiently wide to include all local wing-root interference was obtained by integrating graphically the drag intensity contours of Figs. 9, 10.
- (b) Estimates of the drag of the separate portions of the wing and fuselage included in the above area were obtained by an examination of Figs. 12, 13, by extrapolating the curve of drag/foot run through the indeterminate area behind the wing root. The values used are shown in these figures by chain-dotted lines.
- (c) The difference between (a) and (b) allowing for the portion of the fuselage covered by the wing was taken to be the wing-root interference.

The drag of the wing with the cooling duct closed and away from the influence of the fuselage was found by integrating the curve of Fig. 8. The value agrees with that obtained by interpolating the data given in Young and Squire<sup>3</sup> on the assumption that the transition point occurs at  $0.08c$ .

Tests with the radiator duct open were made with the cooling flap in the top-speed position as shown in Fig. 14, which also shows the velocity distribution at the duct exit. For extrapolation of the curve of drag per foot run behind the wing, shown in Fig. 9, the value behind the fixed part of the duct was estimated from the value behind the flapped portion, assuming that, as the total head was approximately constant across the duct exit, the internal drag varied as the flow, assuming the external drag to be unaltered.

It will be seen from Fig. 12 that the value of drag per foot run round the fuselage at the lower integration limit is less than flat-plate skin-friction drag. This is probably due to the action of cross-flows and the value of the flat-plate skin-friction drag per foot run has been used.

The results of the interference measurements are tabulated below :

<i>Local fuselage wing-root interference drag.</i>	<i>Total for both sides</i>
	lb at 100 ft/sec
With radiator cooling duct closed .. .. .	2.0
With radiator cooling duct open to give the flow for top-speed condition .. .. .	2.2

These two results indicate that the wing-fuselage junction (which has no fillet at the trailing edge) is reasonably satisfactory. It is considered that the addition of leading-edge fillets to reduce the external cooling drag will not affect the above values of wing-fuselage interference.

An examination of Figs. 9, 10, shows a local bulge near the bottom centre-line of the fuselage which is caused by a lip protruding about 1 in. below the fuselage in front of the cartridge chute exits. The increase in drag due to this lip from integration of the drag-intensity contours is about 0.5 lb.

4.2. *Distribution of External Cooling Drag.*—The difference between the drags obtained by integrating the drag-intensity contours with and without radiator cooling between the extreme limits of Figs. 9, 10 will give the cooling drag between these limits. This should include the whole of the internal and external cooling drag except for any part (presumably external drag) which is concentrated near the nacelle junction. The integrated amount was 3.6 lb of which 3.1 lb had been found to be internal cooling drag by previous cooling-flow measurements<sup>1</sup> leaving 0.5 lb as external cooling drag distributed over the wing and the fuselage end of the cooling duct. Since the total cooling drag per duct as found previously is 4.8 lb, the remainder of 1.2 lb is external cooling drag at the nacelle end of the duct. This drag must appear somewhere and it will be presumed to be included in the drag obtained by integration of the contours round the nacelle.



4.3. *Nacelle Drag*.—The examination and analysis of the nacelle drag from the contour diagrams of Fig. 11 is somewhat complex owing to the additional effects of the radiator cooling duct, the exhausts and the supporting structure in the tunnel. A clearer idea could have been obtained if time had permitted a further exploration with the radiator cooling duct faired over, but in the absence of this a crude analysis will be attempted in order to obtain a value for nacelle-wing interference to compare with the one for the wing-fuselage given in section 4.1.

The pylon-support drag has been eliminated by substituting the broken contour lines for the full ones near the bottom of the nacelle. These are such that the integrated value per foot run at the bottom of the nacelle agrees with a calculated value\*. The modified contour lines have been integrated up to the limit shown in Fig 11, this being assumed to be sufficient to include the wing-nacelle interference and that part of the external cooling drag concentrated near the nacelle. The drag of the half nacelle has been obtained by subtracting from this value the profile drag of the wing alone plus the proportionate amount of the internal cooling drag included in the same area.

The drag so obtained is 5.9 lb, and assuming as in section 4.2 that this includes 1.2 lb of external cooling drag, then the profile drag of the half-nacelle on a plain wing would be 4.7 lb or say 9.4 lb for the whole nacelle. This value includes any wing-nacelle interference, drag of the exhaust system and drag of leaks in the cowling panels, but excludes any induced drag.

The drag of one exhaust complete with its cooling duct and cowling leak above that of a faired blister† on the nacelle has been found both by direct balance readings and by the difference between the two diagrams of Fig. 11 to be 1.6 lb; the estimated drag of this blister is about 0.4 lb so that the total drag of the exhaust system for one nacelle is about 4.0 lb. With other cowling leaks of 0.2 lb this leaves 5.2 lb as the drag of a faired nacelle on a plain wing as obtained by the momentum method and represents the drag less any induced drag.

A check on this value is provided by the 24-ft Wind Tunnel tests<sup>5</sup> on a model of the faired nacelle on a stub wing. The nacelle drag was 6.2 lb at 100 ft/sec of which about 1.5 lb is induced drag.

The value of 5.2 lb includes the profile drag of the nacelle with wing removed less a proportion due to the fact that part of the nacelle is submerged in the wing. The main item of any residue is the interference effect of the wing-nacelle junction on the profile drag. A rough estimate on these lines has been made by utilising the calculations by Young<sup>4</sup> as previously mentioned on the profile drag of a body of revolution and from them it is considered that the residue is about 1.2 lb. The accuracy of this determination is, of course, not very high but it serves to give an idea of the interference drag for comparison with the value on the fuselage side as given in section 4.1.

A summary of this discussion gives the following rough estimate of the drag of one nacelle:—

	lb at 100 ft/sec
Profile drag of free nacelle .. .. .	4.0
Excess profile drag due to wing-nacelle interference ..	1.2
Exhausts (including exhaust cooling and cowling leaks) ..	4.0
Other cowling leaks and spinner gap .. .. .	0.2
Induced drag .. .. .	1.5
Total .. .. .	10.9

\* This value is derived from calculations by Young<sup>4</sup> on the profile drag of a body of revolution.

† The blister is necessary to fair off the exhaust cooling-duct entry, which is part of the nacelle cowling and cannot be removed with the rest of the exhaust. The entry was blocked and faired forward on to the spinner and the rear part was faired gently back to the nacelle by means of doped fabric.

In addition to this there is the external cooling drag associated with the nacelle end of the duct which is 1.2 lb/nacelle and which can be reduced to 0.6 lb by the addition of the leading-edge fairing described in Part I of this report<sup>1</sup>.

5. *Accuracy of Method.*—The experimental accuracy is quite good as can be seen by the actual value of drag intensity plotted on Fig. 8, and the integration of any region of the contours of Figs. 9, 10, 11 is considered to give an answer correct to about  $\pm 0.1$  lb.

The difficulty lies in interpreting the meaning of the integrated values. It is essential to realise that the wakes from two independent sources of drag may intermingle at a plane some distance behind these sources due to unsuspected cross flow. Thus the contours in Fig. 11 have a neck situated near the wing nacelle junctions. By integrating separately the part above and below this neck it is apparent that most of the 1.2 lb of external cooling drag is included in the bulge below this neck and is superimposed on the wake from the exhaust. At first sight, it would appear difficult for this external cooling drag to pass through the contour neck but an examination of the elevation of Fig. 15 shows this to be possible. If more time had been available, tests would have been made with the addition of the Plasticine fairings<sup>1</sup> which reduced this external drag.

6. *Conclusions.*—(a) The wing-fuselage interference effect on profile drag is about 2.0 lb at 100 ft/sec and the wing-nacelle interference is about 1.0 lb/nacelle.

(b) The external cooling drag appears to be concentrated at the two sides of the ducts, about 0.5 lb/duct being at the fuselage side and 1.2 lb at the nacelle side. It follows from the drag tests reported previously<sup>1</sup> that the modified entrance would eliminate the external drag at the fuselage side and leave about 0.6 lb at the nacelle side. It therefore appears possible to improve this side.

(c) The drag of each nacelle is about 10.9 lb and 4.0 lb of this is due to the exhaust system. The modified exhaust cooling duct tried in the first part of this report reduces the exhaust drag to 2.7 lb which is still rather high, and suggests a possibility of further improvement.

## REFERENCES

<i>No.</i>	<i>Author</i>	<i>Title, etc.</i>
1	T. V. Somerville .. .. .	Tests on the Whirlwind L.6844 in the 24-ft tunnel. R.A.E. Report, B.A. Departmental Note, Large Wind Tunnel No. 31. May, 1940.
2	The Cambridge University Aeronautics Laboratory.	Measurement of Profile Drag by the Pitot-Traversal Method. R. & M. No. 1688. January, 1936.
3	A. D. Young and H. B. Squire ..	Note on the Results of Wing Profile Drag Calculations. R.A.E. Report No. B.A. 1391b. March, 1938.
4	A. D. Young .. .. .	The Calculations of the Total and Skin-Friction Drags of Bodies of Revolution at Zero Incidence. R.A.E. Report No. B.A. 1533. April, 1939.
5	R. A. Shaw and M. J. McInerney ..	Tests of a Peregrine Nacelle Wing Unit in the 24-ft tunnel. R.A.E. Report No. B.A. 1460. May, 1938.

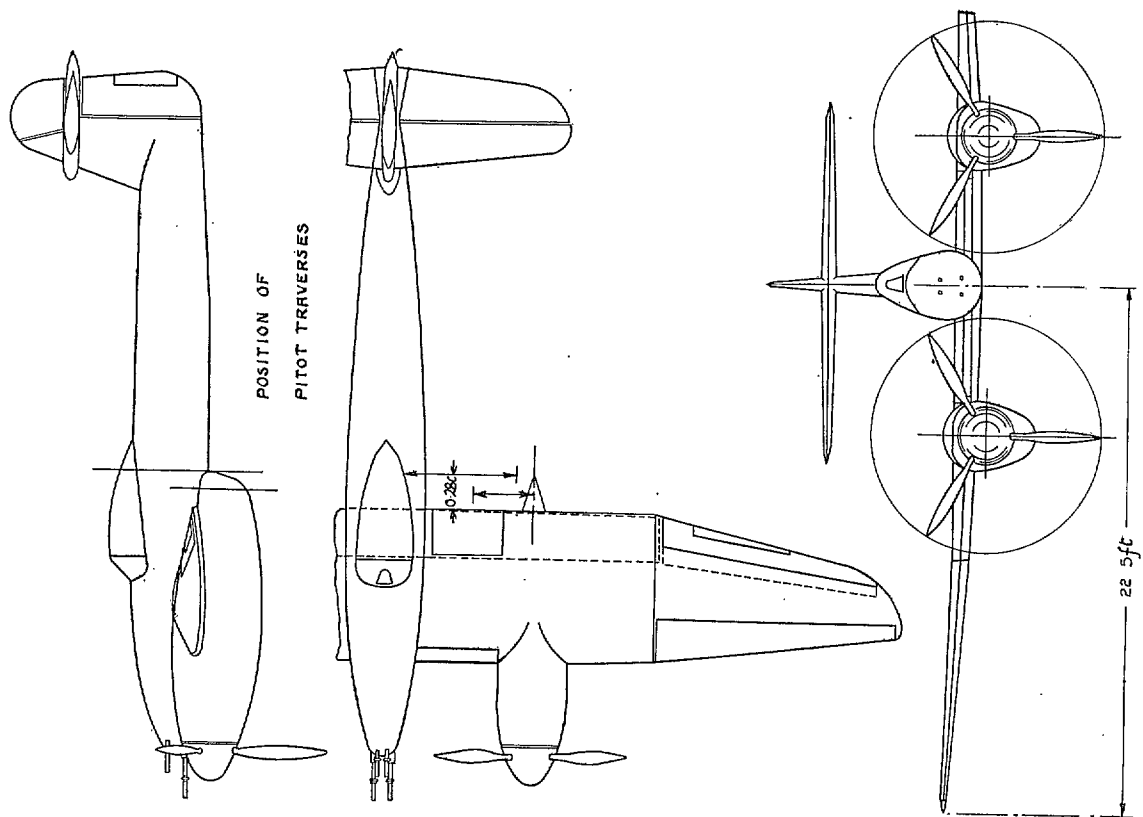

FIG. 1. General Arrangement of *Whirlwind* Aircraft.

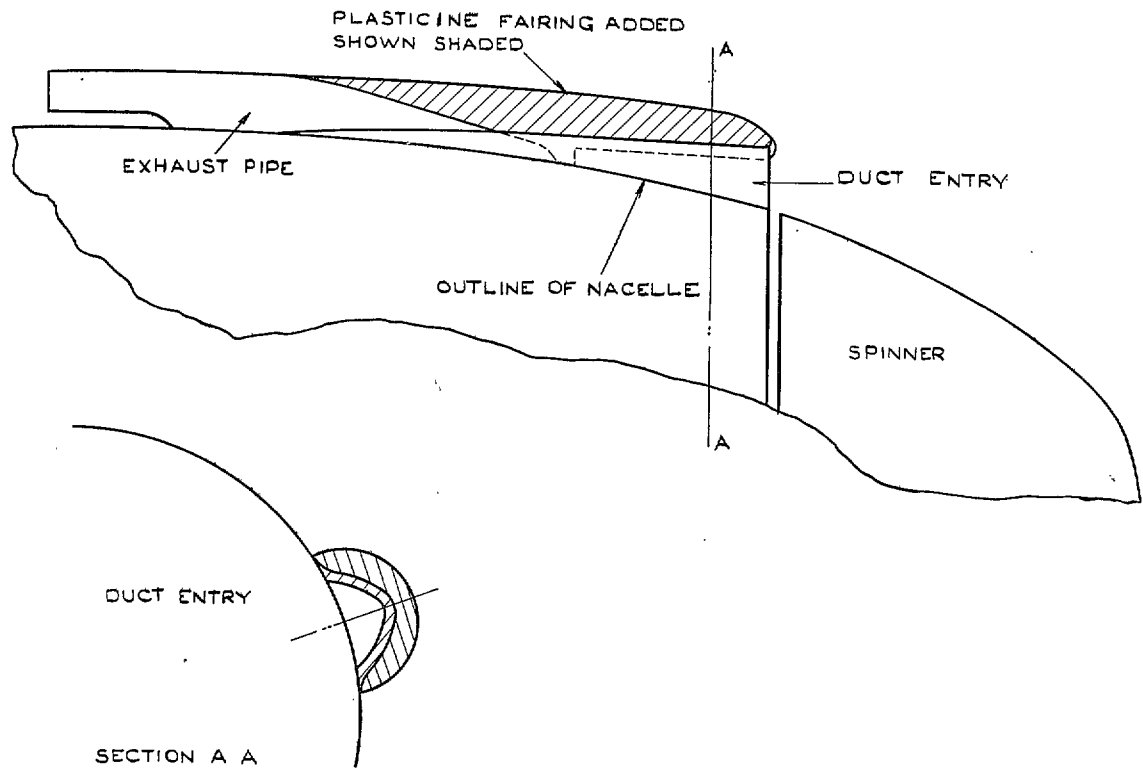

FIG. 2. Shape of Fairing for Duct Entry and Exhaust Manifold on Starboard Nacelle on *Whirlwind*.

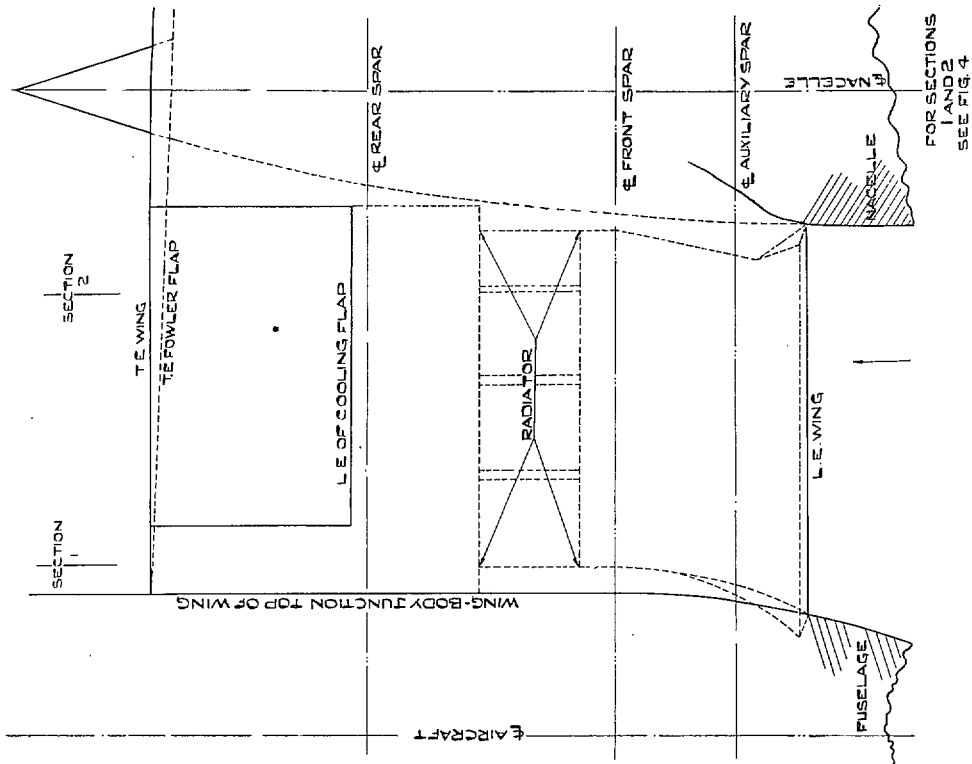

FIG. 3. Plan View of Inner Wing Showing Radiator Duct.

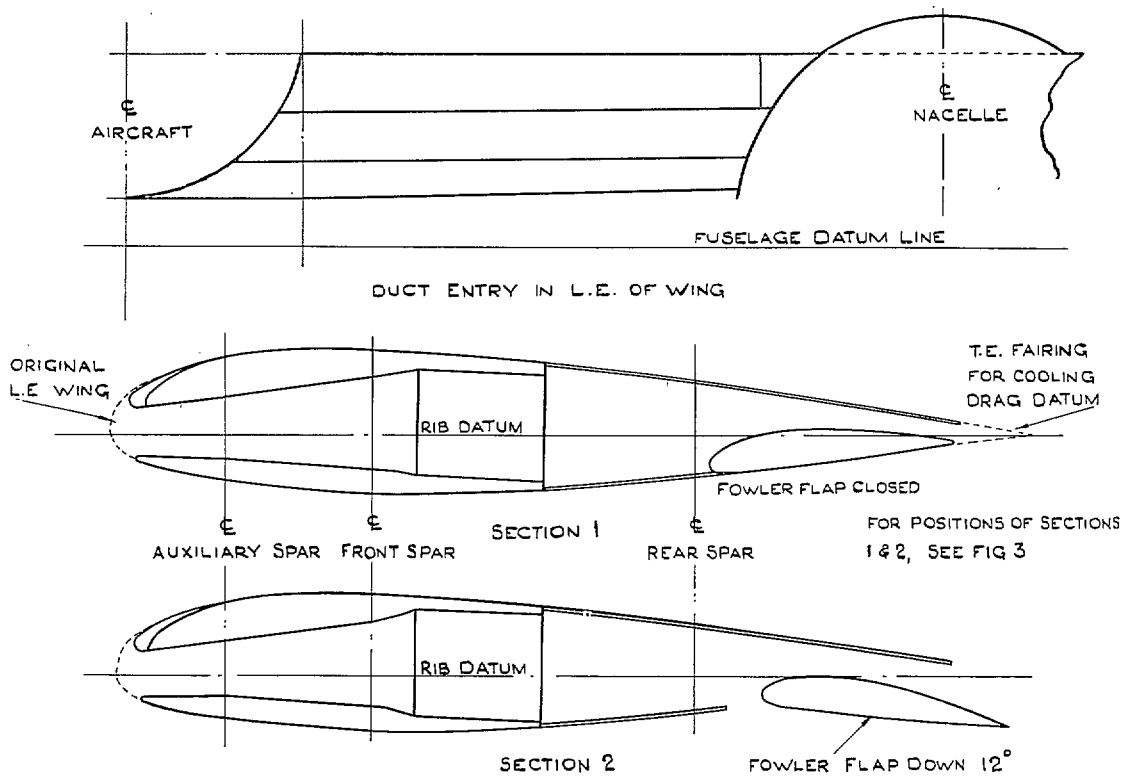

FIG. 4. Radiator Duct Entry and Sections.



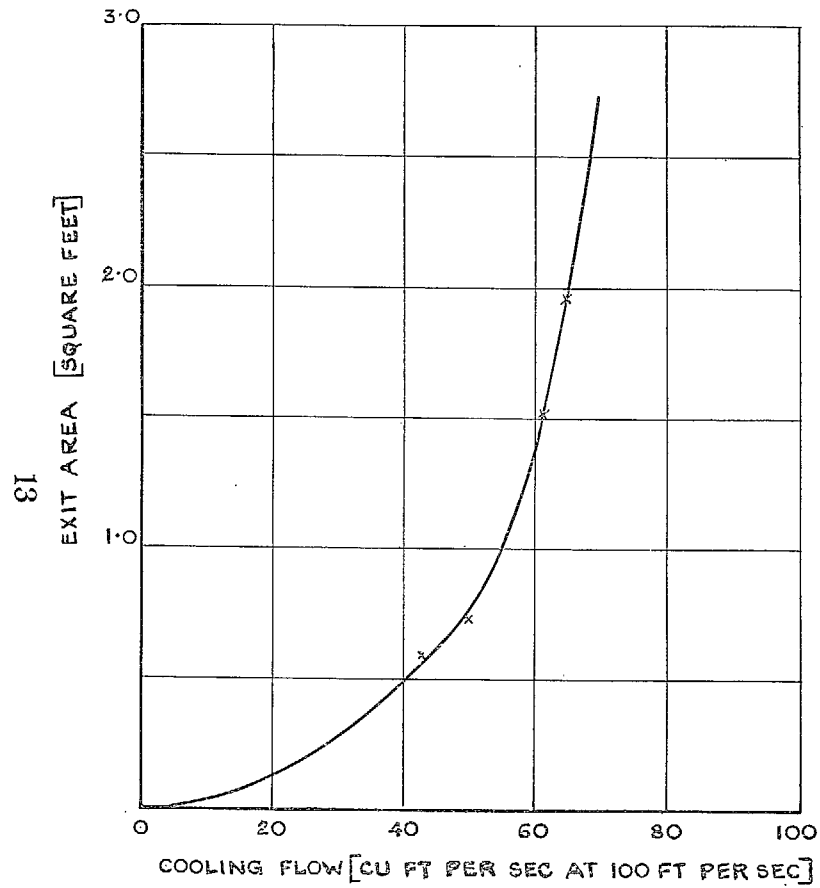

FIG. 7. Variation of Cooling Flow with Exit Area. (One Engine Only.) Incidence 2.3 deg. Cooling flap varied. Fowler flap fixed neutral.

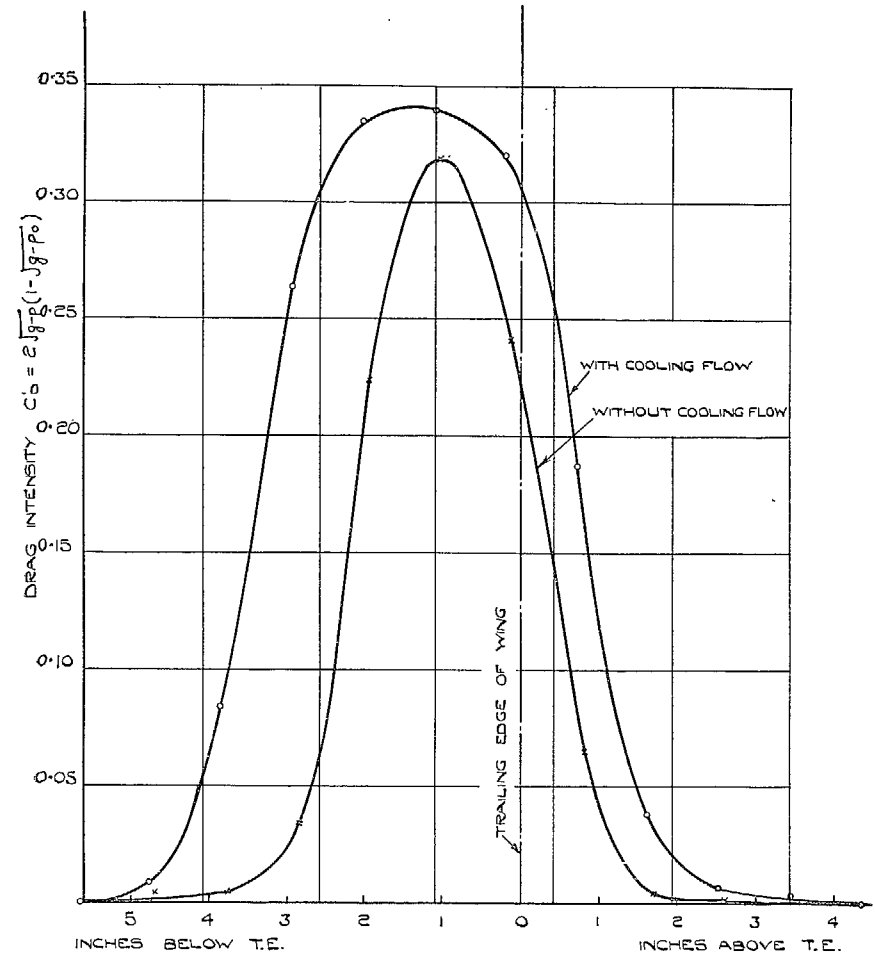

FIG. 8. Distribution of Drag Intensity across Wing Wake behind Radiator with and without Cooling Flow. 3.25 ft from Fuselage centre-line.

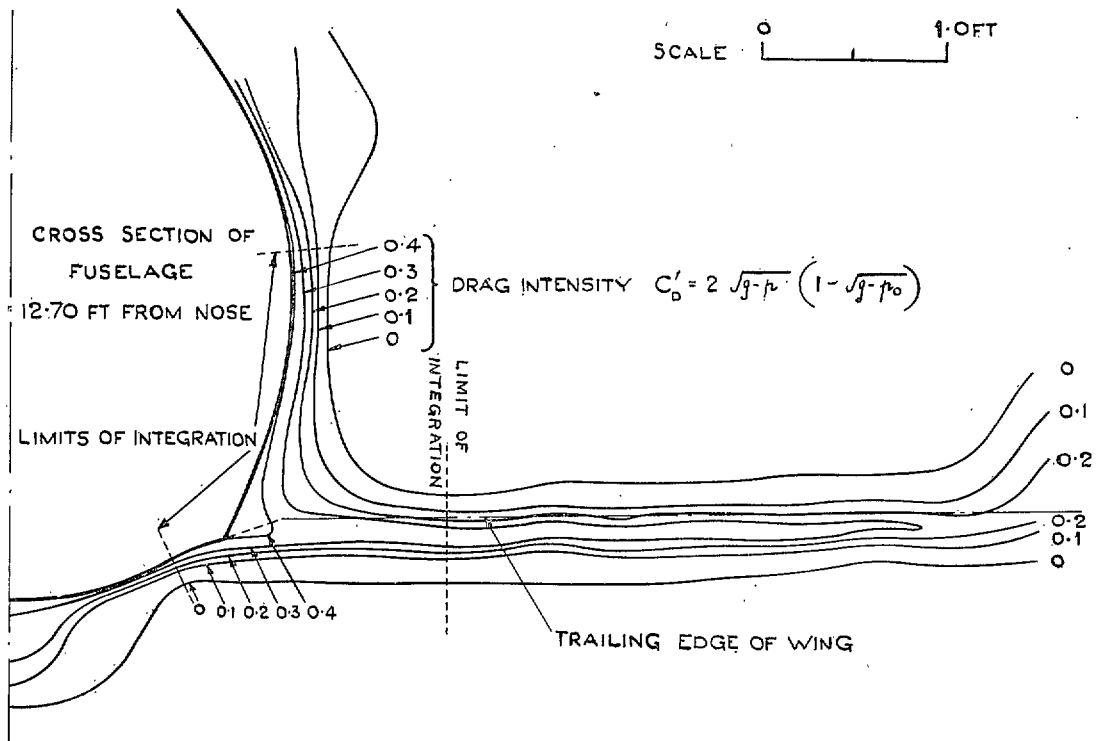

FIG. 9. Contours of Drag Intensity,  $C'_D = 2 \sqrt{g-p} [1 - \sqrt{g-p_0}]$  Behind Wing-Fuselage Junction without Cooling Flow. Plane of Traverse  $0.28c$  behind Wing trailing edge.

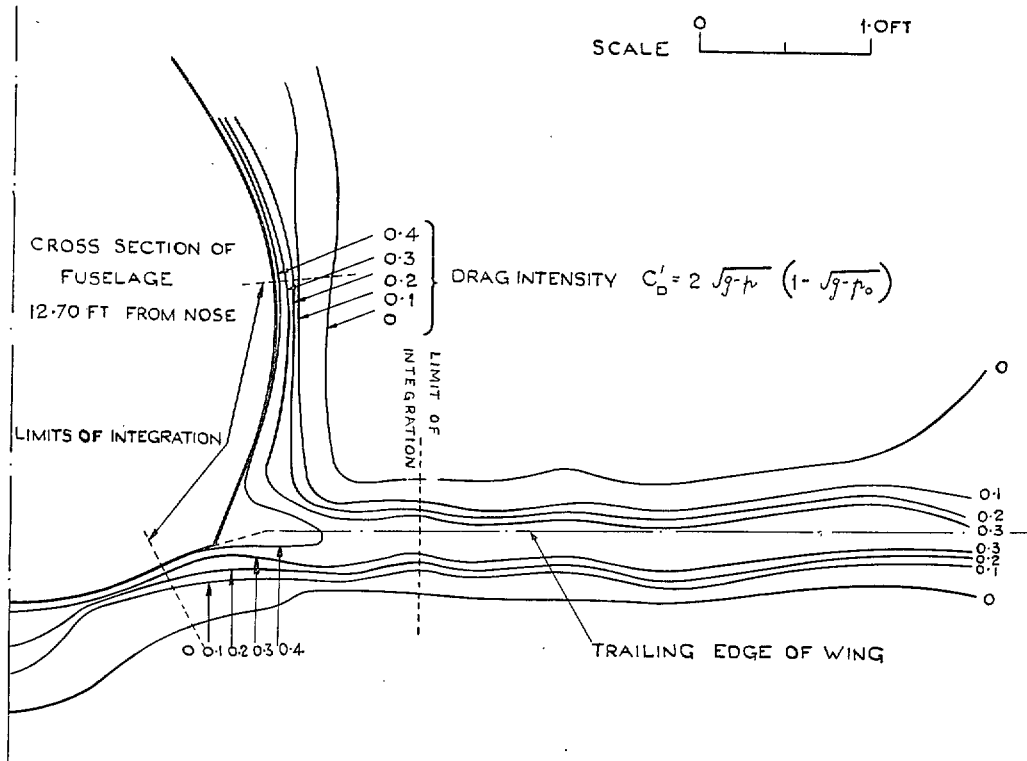

FIG. 10. Contours of Drag Intensity,  $C'_D = 2 \sqrt{g-p} [1 - \sqrt{g-p_0}]$  Behind Wing-Fuselage Junction with Cooling Flow. Plane of Traverse  $0.28c$  behind Wing trailing edge.





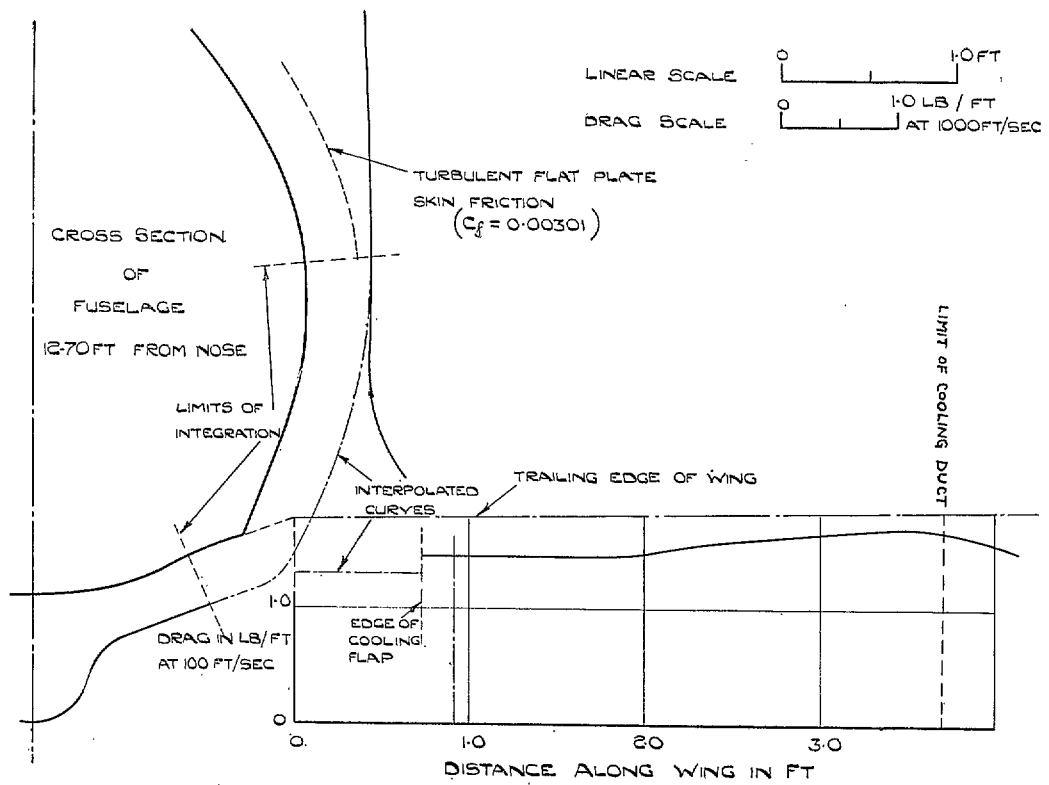

FIG. 13. Distribution of Drag behind Wing Root with Cooling Flow.

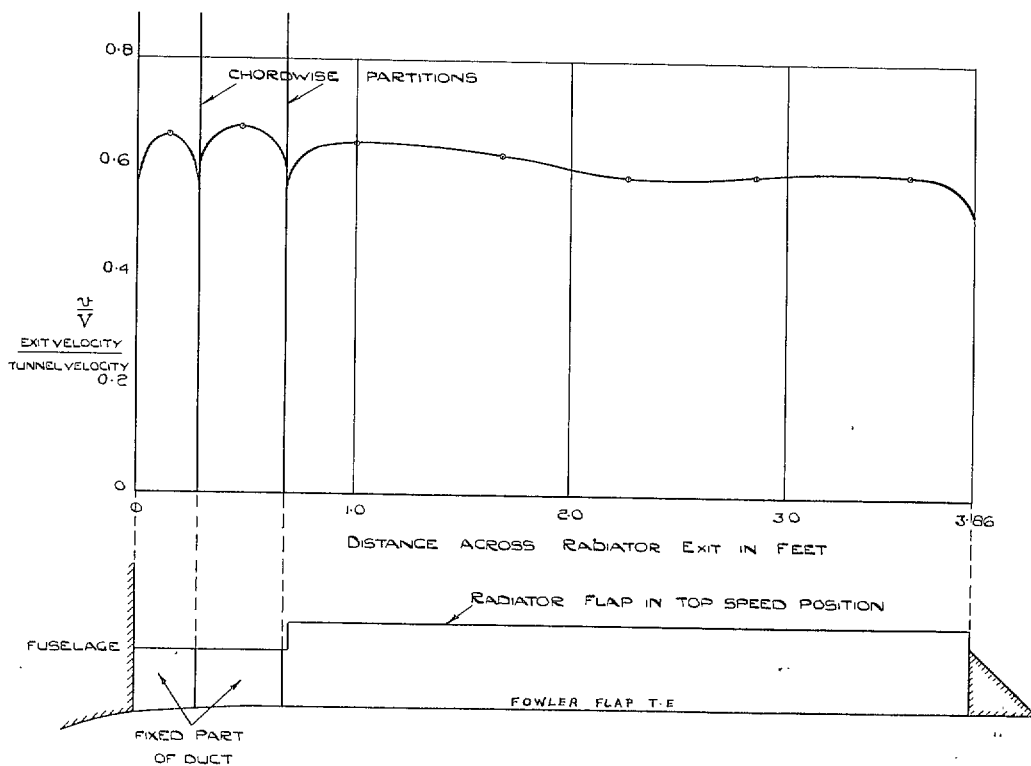

FIG. 14. Velocity Distribution across Radiator Exit.

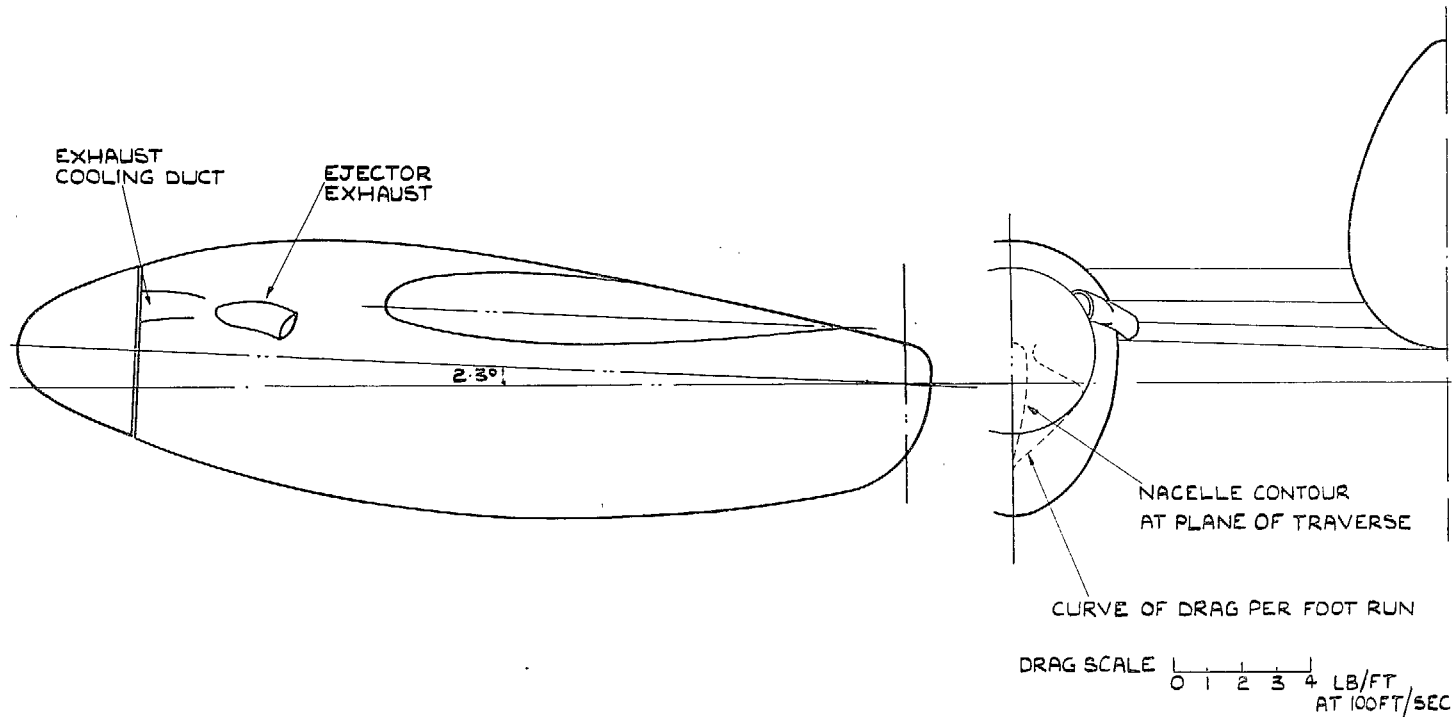

FIG. 15. View of Nacelle showing Relative Positions of Exhaust and Cooling Duct.

# Publications of the Aeronautical Research Council

## ANNUAL TECHNICAL REPORTS OF THE AERONAUTICAL RESEARCH COUNCIL (BOUND VOLUMES)

- 1936 Vol. I. Aerodynamics General, Performance, Airscrews, Flutter and Spinning. 40s. (40s. 9d.)  
Vol. II. Stability and Control, Structures, Seaplanes, Engines, etc. 50s. (50s. 10d.)
- 1937 Vol. I. Aerodynamics General, Performance, Airscrews, Flutter and Spinning. 40s. (40s. 10d.)  
Vol. II. Stability and Control, Structures, Seaplanes, Engines, etc. 60s. (61s.)
- 1938 Vol. I. Aerodynamics General, Performance, Airscrews. 50s. (51s.)  
Vol. II. Stability and Control, Flutter, Structures, Seaplanes, Wind Tunnels, Materials. 30s.  
(30s. 9d.)
- 1939 Vol. I. Aerodynamics General, Performance, Airscrews, Engines. 50s. (50s. 11d.)  
Vol. II. Stability and Control, Flutter and Vibration, Instruments, Structures, Seaplanes, etc.  
63s. (64s. 2d.)
- 1940 Aero and Hydrodynamics, Aerofoils, Airscrews, Engines, Flutter, Icing, Stability and Control,  
Structures, and a miscellaneous section. 50s. (51s.)
- 1941 Aero and Hydrodynamics, Aerofoils, Airscrews, Engines, Flutter, Stability and Control,  
Structures. 63s. (64s. 2d.)
- 1942 Vol. I. Aero and Hydrodynamics, Aerofoils, Airscrews, Engines. 75s. (76s. 3d.)  
Vol. II. Noise, Parachutes, Stability and Control, Structures, Vibration, Wind Tunnels.  
47s. 6d. (48s. 5d.)
- 1943 Vol. I. (*In the press.*)  
Vol. II. (*In the press.*)

## ANNUAL REPORTS OF THE AERONAUTICAL RESEARCH COUNCIL—

1933-34	1s. 6d. (1s. 8d.)	1937	2s. (2s. 2d.)
1934-35	1s. 6d. (1s. 8d.)	1938	1s. 6d. (1s. 8d.)
April 1, 1935 to Dec. 31, 1936.	4s. (4s. 4d.)	1939-48	3s. (3s. 2d.)

## INDEX TO ALL REPORTS AND MEMORANDA PUBLISHED IN THE ANNUAL TECHNICAL REPORTS, AND SEPARATELY—

April, 1950 - - - - R. & M. No. 2600. 2s. 6d. (2s. 7½d.)

## AUTHOR INDEX TO ALL REPORTS AND MEMORANDA OF THE AERONAUTICAL RESEARCH COUNCIL—

1909-1949. R. & M. No. 2570. 15s. (15s. 3d.)

## INDEXES TO THE TECHNICAL REPORTS OF THE AERONAUTICAL RESEARCH COUNCIL—

December 1, 1936 — June 30, 1939.	R. & M. No. 1850.	1s. 3d. (1s. 4½d.)
July 1, 1939 — June 30, 1945.	R. & M. No. 1950.	1s. (1s. 1½d.)
July 1, 1945 — June 30, 1946.	R. & M. No. 2050.	1s. (1s. 1½d.)
July 1, 1946 — December 31, 1946.	R. & M. No. 2150.	1s. 3d. (1s. 4½d.)
January 1, 1947 — June 30, 1947.	R. & M. No. 2250.	1s. 3d. (1s. 4½d.)
July, 1951.	R. & M. No. 2350.	1s. 9d. (1s. 10½d.)

*Prices in brackets include postage.*

Obtainable from

## HER MAJESTY'S STATIONERY OFFICE

York House, Kingsway, London, W.C.2; 423 Oxford Street, London, W.1 (Post Orders:  
P.O. Box 569, London, S.E.1); 13a Castle Street, Edinburgh 2; 39, King Street, Manchester, 2;  
2 Edmund Street, Birmingham 3; 1 St. Andrew's Crescent, Cardiff; Tower Lane, Bristol 1;  
80 Chichester Street, Belfast, or through any bookseller